

86H 28453

Copy No. 2

~~CONFIDENTIAL~~

ACR No. 5120



NOV 13 1945

NATIONAL ADVISORY COMMITTEE FOR AERONAUTICS

CLASSIFICATION CANCELLED

NACA Release form #645, July 3, 1951

ADVANCE CONFIDENTIAL REPORT
Auth: H. L. Dryden
Dir., Aeron. Eng. Div.

HAR

See

7-13-51

AN EXPERIMENTAL INVESTIGATION OF, NACA

SUBMERGED-DUCT ENTRANCES

By Charles W. Frick, Wallace F. Davis, Lauros
M. Randall, and Emmet A. Mossman

Ames Aeronautical Laboratory
Moffett Field, Calif.



Washington
October 1945

NACA LIBRARY
LANGLEY MEMORIAL AERONAUTICAL
LABORATORY
Langley Field, Va.

CLASSIFIED DOCUMENT

This document contains classified information affecting the National Defense of the United States within the meaning of the Espionage Laws of the United States and the Federal Government who have a legitimate interest therein, and its transmission or communication to any person is prohibited by law. Information so classified may be imparted only to persons in the military and naval services of the United States, appropriate civilian officers and employees of the Federal Government who have a legitimate interest therein, and to those persons of known loyalty and discretion who of necessity must be informed thereof.

~~CONFIDENTIAL~~

~~RESTRICTED~~

Notice
This material may be protected by Copyright
Law (Title 17 U. S. Code)

~~RESTRICTED~~

NACA ACR No. 5120

~~CONFIDENTIAL~~

NATIONAL ADVISORY COMMITTEE FOR AERONAUTICS

ADVANCE CONFIDENTIAL REPORT

AN EXPERIMENTAL INVESTIGATION OF NACA
SUBMERGED-DUCT ENTRANCES

By Charles W. Frick, Wallace F. Davis,
Lauros M. Randall, and Emmet A. Mossman

SUMMARY

The results of a preliminary investigation of submerged-duct entrances are presented. It is shown that an entrance of this type possesses desirable critical speed and pressure-recovery characteristics when used on a fuselage or nacelle in a region of low incremental velocity and thin boundary layer. The data obtained indicate that submerged entrances are most suitable for use with internal-flow systems which diffuse the air only a small amount: for example, those used with jet motors which have axial-flow compressors. Where complete diffusion of the air is required, fuselage-nose or wing-leading-edge inlets may prove to be superior.

The results of the investigation have been prepared in such a form as to permit their use by a designer and the application of these data to a specific design is discussed.

INTRODUCTION

The use of the jet-propulsion motor has greatly intensified the need for efficient air-induction systems for high-speed aircraft. Although the air quantities used by such motors are not greatly in excess of the over-all air requirements of conventional aircraft engines of equivalent high-speed thrust, the performance of a jet motor is affected to a much greater extent by pressure losses in the air-induction system resulting from poor design. At high speed, a loss in total pressure of 10 percent of the free-stream dynamic pressure for the air supplied to the jet motor of a typical fighter aircraft may result in a

~~CONFIDENTIAL~~
~~RESTRICTED~~

loss in thrust equivalent to about one-tenth of the airplane drag. When it is realized that very few of the air-induction systems of existing jet-propelled aircraft have total pressure recoveries of more than 65 percent of the free-stream dynamic pressure, it becomes apparent that there is a great need for improved designs.

The National Advisory Committee for Aeronautics, working closely with the Army and Navy, has been conducting extensive research on the problems of jet-motor air-induction systems at its various laboratories. Results of this research concerned with fuselage-nose inlets and external scoops have been published in references 1 and 2.

As a part of this research program, the Ames Aeronautical Laboratory has undertaken the investigation of air inlets submerged below the surface of the body into which the entrance is placed. This type of air inlet is not new, having been tested first during the duct-entry research of reference 3. Submerged and semisubmerged inlets have also received considerable attention from various aircraft manufacturers. It is the purpose of the investigation reported herein to provide more complete information on entrances of this type so as to define their relative merits compared with other types of inlets.

A study of the geometric characteristics of submerged air inlets indicated the following possible advantages:

1. Reduction of the length of the internal ducting and the elimination of ducting bends with a saving in weight and reduction in pressure losses compared to a wing-leading-edge or fuselage-nose inlets
2. Reduction in external drag when compared with external fuselage scoops
3. Easier attainment of high critical speed at high-speed attitude than for external fuselage scoops and a wider range of airplane attitude for high critical speed than for a wing leading edge or fuselage-nose entrance

It was believed that these advantages would favor the use of such entrances for certain air-induction systems, provided that design methods could be established to eliminate the characteristic low pressure recovery.

MODEL AND APPARATUS

The general investigation of the submerged entrances was made in the Ames 1- by 1.5-foot wind channel shown in figure 1. This wind channel is of the open-return type and is powered with a high-capacity centrifugal blower capable of producing a maximum airspeed of 180 miles per hour in the test section. The air stream itself is very smooth and probably of low turbulence because of the contraction ratio of 13.0 to 1.0.

Measurements of the tunnel air stream indicated an appreciably thick boundary on the walls of the test section. In order to obtain the thinnest boundary layer possible, a false wall was built into the wind-tunnel test section so that the tunnel-wall boundary layer passed between the false and true walls of the tunnel. The model submerged duct was placed in this false wall as shown in figure 1. Air flow into the model duct entrance was controlled through the use of a small centrifugal blower.

The model of the submerged-duct entrance was so designed that the contours of the lip, the angle of the entrance ramp (fig. 1) and the divergence of the ramp could be changed without removing the other duct parts. The openings tested were of 4-square-inch area; one of 4- by 1-inch and the other 2- by 2-inch dimension. For all tests, the air drawn into the entrance was expanded to a very low velocity in an 8° conical diffuser of 15.0 to 1.0 area ratio. Figure 2 shows a view of one of the entrances tested.

A specific application of the results of the general investigation was tested on a 0.25-scale model of a fighter-type aircraft in the Ames 7- by 10-foot wind tunnel No. 1. Views of the submerged duct for this model are shown in figures 3 (a) and (b).

TESTS AND TEST METHODS

Measurements of the pressure losses of the air flowing into the submerged duct for the tests in the Ames 1- by 1.5-foot wind channel were made both at the entrance and at the end of the diffuser. The placing of the total-pressure tubes and the static-pressure tubes in the entrance is shown

in figure 4. Pressure losses at the end of the diffuser were measured with total-pressure tubes. It should be noted that all measurements of the pressure recovery at the end of the diffuser were made while the pressure-measuring rakes were located in the duct inlet. The pressure losses resulting from the drag of these rakes are of considerable magnitude and the data obtained for the diffuser are of comparative value only. This in no way detracts from the value of these measurements since they are used for comparing the effects of various changes to the entrance. Data useful to the designer were obtained with the rakes at the duct entrance by plotting contours of pressure loss in the entrance from the measured values obtained with the pressure-measuring tubes of figure 4 and integrating these pressure losses to obtain the average loss. Losses measured with these rakes represent the value obtained with 100-percent diffuser efficiency. Data for other diffuser efficiencies may be computed from these measurements. For all tests, the inlet-velocity ratios are mean values determined from air-quantity measurements made with a calibrated venturi meter located in the air duct leading to the centrifugal blower.

Pressure-distribution tests were made over the lip and the ramp of the entrance to permit an estimation of the critical speed. Pressure data obtained with flush orifices were used with reference 4 to obtain values of the critical Mach numbers for various operating conditions.

The effects of removing the boundary layer of the surface ahead of the submerged duct were determined by testing suction slots at various locations ahead of the duct entrance. A small centrifugal blower was used to provide suction. Air quantities were measured with a calibrated venturi. A sketch of the boundary-layer-control test duct is shown in figure 5.

Nearly all tests were made by holding the tunnel air-speed constant and varying the air quantity flowing in the duct to vary the inlet-velocity ratio. A few tests were made at very high inlet-velocity ratios by reducing the tunnel airspeed.

Tests of submerged-duct entrances for the 0.25-scale model of the fighter aircraft were made by inducing air flow into the inlets with an air pump connected to a channel in the spar of the tip-supported model. The inlet-velocity

ratio was held constant while the model angle of attack was varied. Pressure losses were measured at the simulated entrance to the Halford jet motor with a rake of 17 total-pressure-measuring tubes in each duct.

RESULTS AND DISCUSSION

General Investigation

The investigation of the submerged-duct entrances in the small wind channel was divided into phases, each concerned with one particular design variable. These variables were as follows:

1. Ramp design
2. Lip design
3. Entrance shape and aspect ratio
4. Boundary-layer thickness

The discussion deals with each of these variables separately. Portions of the discussion are also devoted to the few tests of boundary-layer control and to the external-drag characteristics. Figure 2 defines the various elements of the submerged entrance.

Ramp design.— During the preliminary tests of the submerged entrances, the pressure recoveries obtained both at the end of the diffuser and at the duct entrance were disappointingly low. A maximum value of pressure recovery of about 57 percent was measured after complete diffusion at an inlet-velocity ratio of 0.5. The pressure recovery decreased to zero when the inlet-velocity ratio was increased to a value of 1.3. The entrance tested consisted of a 1- by 4-inch opening at the end of a 7° ramp bounded by straight parallel walls. Since at inlet-velocity ratios of less than 1.0, more air enters the upstream end of the ramp than flows into the entrance with resultant spillage over the sides and, since the streamlines of the flow diverge as the opening is approached, it was suggested that some improvement might be obtained by diverging the walls of the ramp to fit the streamlines more closely. Tests of the first divergent walls showed a surprising increase in the pressure recovery of 8 to 10 percent at inlet-velocity ratios of less than 1.0. In order to investigate this further, tests of various straight divergent walls and one curved divergent wall as shown in figure 6 and table I were made. The results

of these tests are shown in figure 7. The best pressure recoveries were obtained with the curved divergence 4 which gave a maximum pressure recovery of 73 percent at an inlet-velocity ratio of 0.40. Improvement was also found at inlet-velocity ratios greater than unity. It should be explained that the measure of divergence used in this investigation is the ratio of the width of the entrance of the ramp to the width of the submerged entrance. An examination of the pressure-loss data of figure 8(a) obtained in the duct entrance shows that the effect of the divergent walls is to reduce appreciably the losses suffered by the air entering the duct. The improvement of flow losses found at inlet-velocity ratios of 1.0 or greater indicates that fitting the contour of the ramp walls to the streamlines does not give a full explanation of the reduction of pressure losses. It is surmised that the divergent walls of the ramp act to reduce the amount of boundary-layer air which flows down the ramp, thereby increasing the pressure recovery at all inlet-velocity ratios.

It was noticed, however, that while the pressure losses were much improved over the entrance as a whole, higher losses than those obtained with no divergence were found in a small region close to the sides in the upper half of the opening just below the lip. This effect is shown by the data of figure 8(b) taken for the pressure rake mounted one-half inch from the opening. Flow studies indicated that these pressure losses were originating in a short stalled region along the walls of the ramp. Attempts made to improve this condition by rounding the edges of the walls resulted in even greater losses. It was found that by placing small ridges or deflectors of a maximum height of one-half inch along the top of the divergent walls as shown in figure 9, an appreciable gain could be obtained at inlet-velocity ratios greater than 0.6. These data are shown in figure 10. The combination of the curved divergence and deflectors increases the maximum pressure recovery after diffusion from 57 percent (fig. 7) to 78 percent (fig. 10) at an inlet-velocity ratio of 0.4 and from 20 to 36 percent at an inlet-velocity ratio of unity. The effect of these deflectors on the losses at the sides of the entrance is shown in figure 11.

The foregoing results were obtained with a ramp angle of 7° . It was necessary, therefore, to determine the effect of changing the ramp angle on the pressure losses and to find out whether the use of divergence was as efficacious with greater ramp angles as for 7° . The results of figure 12 show that, with parallel side walls, an appreciable

improvement in the pressure recovery is experienced with increasing ramp angle especially at the inlet-velocity ratios greater than unity. The results of tests of various ramp angles with divergent walls presented in figure 13 show that, for ramp angles up to 10° , the use of divergent walls results in a reduction of the pressure losses. For 15° , a large loss in pressure recovery was experienced. The results of these tests indicate that, as a ramp angle increases, the divergence used should decrease. Figure 14(a) shows the effect of ramp angle on the pressure distribution along the ramp. Figure 14(b) shows the pressure distribution along the ramp as it varies with inlet-velocity ratio.

Lip design.— In designing a satisfactory lip for the submerged duct, two requirements must be satisfied. First, the lip must have a shape that will give a high critical speed at the low inlet-velocity ratios used in high-speed flight; and second, the lip shape must be such that no stalling of the internal flow will occur at high inlet-velocity ratios or even at infinite inlet-velocity ratio corresponding to the static ground operation of the jet motor. With these criteria in mind, seven lip shapes were tested. Line drawings of these shapes are given in figure 15, and tables II(a) and II(b) give their ordinates. The results of tests of these lip shapes are given in table III. The first lip tested was poor in all respects, especially insofar as the stalling of the internal flow was concerned. Adding curvature to the inner surface (lip 2) improved these stalling tendencies, but the critical speed was still very poor. Adding curvature to the outer surface (lip 3) did not improve the critical speed and made the internal-flow losses much greater. Adding curvature to both the inside and outside surfaces (lip 4) increase the critical speed and eliminated stalling of the lip except at infinite inlet-velocity ratio. Changing the nose radius (lip 5) did not improve this condition, but an increase in camber and an increase in nose radius resulted in an entirely satisfactory lip (lip 6). A further attempt to improve this lip by increasing the lip radius resulted in a still further decrease in critical speeds. It is concluded that, for the duct tested, lip 6 was entirely satisfactory.

It was anticipated that changing the ramp of the submerged entrances might have an appreciable effect on the angle of flow at the lip and thereby on the critical speed. Tests of lip 6 with a ramp angle of 7° showed a decrease in the

maximum critical speed from M_{cr} of 0.92 to a value of M_{cr} of 0.83 at an inlet-velocity ratio of 0.94 when divergence replaced the nondivergent ramp walls. It was surmised that the increased pressure recovery with the divergent wall was increasing the angle of flow at the lip. While the value of M_{cr} of 0.83 is quite high under normal conditions, the fact that these submerged inlets probably will be used on surfaces over which the velocity is greater than free-stream velocity makes the attainment of the highest possible critical speed for the lip necessary for a satisfactory airplane installation.

In order to counteract the increased angle of flow, the lip of the duct was given 3° of down incidence. The effect of this change in incidence may be determined from a comparison of the pressure-distribution data of figures 16 and 17 which show the lip pressure distribution with zero incidence and with 3° down incidence. The effect of the change on the critical Mach number is shown in figure 18. The maximum critical speed with 3° of down incidence is increased to a value of M_{cr} of 0.92 at an inlet-velocity ratio of 0.85.

It was anticipated further that a change in ramp angle might have an appreciable effect on the critical Mach number of the lip by changing the angle of flow. Data obtained for lip 6, shown in figures 16, 19, and 20, indicate a sizable effect of ramp-angle change on the pressure distribution over the lip. It is possible to compensate for the change in ramp angle by changing the incidence of the lip. This is believed more desirable than changing the camber of the lip itself since it is possible that the contours of the lip might be changed enough to cause stalling of the internal flow at infinite inlet-velocity ratio.

The original lips used for the submerged ducts, as shown by figure 15(a), protruded slightly above the surface. This effect is not detrimental, but it is somewhat easier to fair the ends of the lip and to change its incidence if it is lowered until its upper surface becomes tangent to the surface into which the submerged duct is placed, as shown by figures 2 and 15(b). Tests of this arrangement showed the same characteristics as for the original lip location. Ordinates for the lips so placed are given in table II(b). These lips, when related to the depth of the model-duct entrance, are believed to represent the upper limit of desirable lip size. Tests of submerged

inlets designed for a specific airplane discussed later indicate that the ratio of lip size to duct depth may be reduced to about two-thirds of that used for the lips of tables II(a) and II(b).

Entrance aspect ratio. - A few tests were made to determine the effect of entrance aspect ratio on the pressure-recovery characteristics. Comparative results are shown in figure 21 for the 1- by 4-inch opening (for which most of the research was conducted) and a 2- by 2-inch opening. The effectiveness of diverging the walls for the 2- by 2-inch opening is of comparable magnitude to that found for the 1- by 4-inch entry. The maximum pressure recovery which may be realized for the 2- by 2-inch opening is slightly less than for the rectangular opening. The data of figure 22 indicate that the loss in pressure recovery resulting from a thick boundary layer is somewhat less for the square opening.

Effect of boundary-layer thickness. - All the tests discussed above were made with the normal boundary layer of the false wall of the wind channel noted as boundary layer 1 in figure 23. In order to ascertain the effect of boundary-layer thickness and to provide data applicable to submerged-duct installations far aft on the fuselage of an airplane, tests were also made with the two other boundary-layer thicknesses shown in figure 23. Results of these tests are shown in figure 24. As expected, these thicker boundary layers appreciably reduced the apparent pressure recovery at the end of the diffuser.

In order to ascertain the effect of the deflectors on the pressure recovery, tests were made with both normal and extended deflectors. (See fig. 10.) The results of these tests are shown in figure 25. It may be seen that, for the thinnest boundary layer, the normal deflectors showed an appreciable improvement while the extended deflectors improved the pressure recovery only for a small range of low inlet-velocity ratios. With boundary layer 2, the use of extended deflectors very appreciably increased the pressure recovery. With boundary layer 3, the improvement resulting from the use of deflectors was less. This decrease in the effectiveness of the deflectors is believed due to the fact that the boundary layer was very thick.

As will be shown later in this report, tests of a specific model with a boundary layer thinner than any of those mentioned in the preceding paragraph showed a decrease in

pressure recovery resulting from the extension of the deflectors. Improvement resulted from the use of normal deflectors. It may therefore be concluded that, for all boundary-layer thicknesses, the normal deflectors should be used, but that the deflectors should be extended only when the boundary layer is as thick or thicker than boundary layer 2. In any specific application, the controlling parameter to be used in applying the results of this investigation, insofar as the thickness of boundary layer is concerned, is the ratio of boundary-layer depth to the depth of the submerged entrance.

Boundary-layer control. - Boundary-layer-control tests were made with a suction slot located at various positions along the ramp, as shown in figure 5. The effectiveness of the boundary-layer control was found to be best when the slot was located in the ramp near the inlet. The data obtained with the best slot (slot 4, fig. 5) are given in figures 26 and 27. These data show that, if the flow in the boundary-layer suction slot is about 20 percent of the flow into the submerged inlet, the best results are obtained. However, the improvement obtained by use of boundary-layer control is no greater than is obtained by extending the deflectors. It is believed that the use of extended deflectors will show an over-all increase in airplane performance greater than for boundary-layer control. It is expected, however, that, if the walls of the ramp have no divergence, the effectiveness of the boundary-layer control will be much greater.

Drag. - No drag measurements were made in the general investigation in the Ames 1- by 1.5-foot wind channel. It is impossible to distinguish between the external and internal drag of a submerged inlet in the same manner as for an inlet in the leading edge of a wing or streamline body. Nearly all the air which suffers a loss in momentum due to the presence of the submerged inlet flows into the entrance of the duct where that loss in momentum appears as a pressure loss. For the basic submerged duct it might be said that the external drag is a negative quantity since there probably is an improvement of the flow behind the inlet because of the removal of the boundary layer.

It is expected, however, that the use of deflectors will result in some small external drag; but in view of the large increase in pressure recovery resulting from their use, it is believed they will result in a large net gain.

Application to a Specific Design

As mentioned previously, the results of the general investigation were applied to a specific airplane design and tested on a 0.25-scale model in the Ames 7-by-10-foot wind tunnel. The airplane used for this purpose is a high-speed fighter airplane powered with a Halford jet motor. From the results of the basic research, twin submerged entrances were designed to supply air to the Halford unit at an inlet-velocity ratio of 0.70 at an airspeed of 475 miles per hour at 15,000 feet altitude. The internal ducting was of constant area back to the twin entrances of the jet motor. Pressure losses in the ducting as determined from bench tests were found to be 10 percent of the dynamic pressure of the air flowing in the duct. Views of the submerged inlet are shown in figure 3, and a dimensional sketch is given in figure 28.

The results of tests made for the basic submerged duct and for the inlet with normal deflectors are shown in figure 29. The use of the deflectors appreciably increased the pressure recovery at the high inlet-velocity ratios. Extending the deflectors had a deleterious effect on the pressure recovery. Since the boundary layer was very thin, these results substantiate the theory that the extended deflectors may improve the pressure recovery only if the boundary layer is thick.

The results of tests in which the angle of attack was varied are shown in figure 30. It is interesting to note that the variation of pressure recovery with angle of attack is small. This represents a considerable improvement in flow characteristics over those obtained with an inlet in the leading edge of a wing or streamline body.

The estimated variation of critical Mach number with an inlet-velocity ratio based on measured pressures is given in figure 31. The decrease to a maximum M_{cr} of 0.79 at an inlet-velocity ratio of 0.95 from the value of 0.92 for the basic lip 6 represents the effect of the addition of the incremental velocity over the fuselage. The critical speed of the submerged inlet is much greater than that of other basic parts of the aircraft. The lip used was given approximately 2° of down incidence.

It may be concluded that the application of the results of the general investigation to a specific design presents no

additional problems. It is considered, however, that the use of deflectors on the submerged duct for this design was made even more necessary because the duct was located in a curved surface.

Estimation of Compressibility Effects

It is anticipated that the pressure losses of the air entering the submerged inlet will be appreciably greater at high-speed-flight Mach numbers than those measured for low speeds in the research of this report, especially at low inlet velocity ratios. The effects of compressibility, furthermore will vary with the thickness of the boundary layer of the surface into which the submerged inlet is placed since the pressure losses at the inlet are a function of both the boundary-layer thickness and the pressure gradient along the ramp. At constant inlet-velocity ratio, the effect of compressibility is to increase this pressure gradient. In lieu of high-speed tests, it is possible to estimate the Mach number effects by considering the increase in the ramp pressure gradient with Mach number equivalent to the increase in the ramp pressure gradient with decreasing inlet-velocity ratio.

For a constant boundary-layer thickness it is convenient to write

$$\left(\frac{\Delta H_A}{qA}\right)_{v_A} = f\left(\frac{dp}{dx}\right) = f(M)$$

and

$$\left(\frac{\Delta H_A}{qA}\right)_{v_0} = f\left(\frac{dp}{dx}\right) = f\left[1 - \left(\frac{v_A}{v_0}\right)^2\right]$$

where the subscripts indicate the parameter held constant. Therefore

e
was
a

$$\left(\frac{\Delta H_A}{q_A}\right) = f \left[1 - \left(\frac{V_A}{V_o}\right)_{\text{eff}}^2 \right]$$

where

at
low
inlet-
more,
the

$$\left(\frac{V_A}{V_o}\right)_{\text{eff}} = f(M)$$

and

$$\left(\frac{V_A}{V_o}\right)_{\text{eff}} = \sqrt{1 - \left[1 - \left(\frac{V_A}{V_o}\right)^2 \right] \frac{P_c}{P_1}}$$

or

of
In.
amp
crease
ocity
ient

$$\left(\frac{V_A}{V_o}\right)_{\text{eff}} = \sqrt{1 - \frac{1.43}{M^2} \left[\left\{ 1 - 0.2M^2 \left[\left(\frac{V_A}{V_o}\right)^2 - 1 \right] \right\}^{3.5} - 1 \right]} \quad (1)$$

The entrance pressure losses in terms of free-stream dynamic pressure may also be written as

$$\left(\frac{\Delta H_A}{q_o}\right)_{\text{eff}} = f \left[\left(\frac{V_A}{V_o}\right)_{\text{eff}} \right]$$

then

$$\left(\frac{\Delta H_A}{q_o}\right) = \left(\frac{\Delta H_A}{q_o}\right)_{\text{eff}} \frac{(V_A/V_o)^2}{(V_A/V_o)_{\text{eff}}^2} \left\{ 1 - 0.2M^2 \left[\left(\frac{V_A}{V_o}\right)^2 - 1 \right] \right\}^{2.5} \quad (2)$$

These concepts of effective pressure loss and effective inlet-velocity ratio permit the use of measured low-speed pressure losses in estimating high-speed pressure losses for similar submerged-duct designs. The measured low-speed losses are considered to be effective values. If, for the duct design considered, the variation of Mach number with airspeed and the variation of true inlet-velocity ratio with airspeed are known, use of these data will give an estimate of the variation of the pressure losses at the inlet with airspeed.

Figure 33 shows the effective inlet-velocity ratio as a function of Mach number for various values of true inlet-velocity ratio. These data indicate the necessity of keeping the high-speed inlet-velocity ratio at a rather high value so that the effective inlet-velocity ratio does not become too small.

Estimation of Total Pressure Losses

In order to estimate the total pressure losses up to the face of the jet-motor compressor, the following expression may be used:

$$\frac{\Delta H}{q_0} = \frac{\Delta H_A}{q_0} + (1-\eta) \left(\frac{V_A}{V_0} \right)^2 \left\{ 1 - 0.2M^2 \left[\left(\frac{V_A}{V_0} \right)^2 - 1 \right] \right\}^{2.5}$$

Values of η may be obtained from bench tests of model ducts or may be estimated from existing data. It should be noted that, if the internal ducting consists of a diffuser of large expansion ratio, the effect of the boundary layer along the ramp wall will be to decrease the diffuser efficiency below the value obtained for the idealized entrance conditions.

Data for Use by a Designer

From the preceding discussion of the research the following summary may be given:

1. Ramp design

- (a) The use of divergent walls for the ramp improves

~~CONFIDENTIAL~~

No. 5120

ive
speed
esses
If, for
ber with
tio with
stimate
with

io as a
nlet-
f
ber high
s not

up to
ex-

2.5
}

model
hould
e
se the
e idealized

he fol-

improves

the pressure recovery to such magnitude as to make them mandatory for all installations. The curved divergence shows the best characteristics.

- (b) The ramp angle may be varied up to 10° without incurring serious pressure losses. For a 10° ramp, the pressure losses are slightly greater than for lesser ramp angles. If a 10° ramp is used, a lesser divergence should be used than for smaller ramp angles.

2. Lip design

- (a) Lip shape 6 is satisfactory from the standpoint of critical speed and internal-flow losses.
- (b) The effect of increasing the divergence is to increase the angle of attack of the lip at a given inlet-velocity ratio. This effect is believed due to increased divergence of the streamlines at the entrance resulting from increased pressure recovery.
- (c) The effect of increasing the ramp angle is to decrease the angle of attack of the lip.
- (d) For any ramp angle selected, similar critical-speed characteristics may be obtained by selecting the proper lip incidence.
- (e) The use of a lip submerged below the surface into which the entrance is placed so that the lip contour becomes tangent to the surface at its maximum thickness is believed to be more satisfactory than the protruding lip. Further investigation of this point is needed.

3. Entrance aspect ratio

- (a) Use of a square entrance in the place of a rectangular one of aspect ratio 4.0 shows slightly greater pressure losses. The data covering aspect ratio effects are meager and further research is needed for determining optimum aspect ratios.

4. Boundary-layer thickness

- (a) Increasing the boundary-layer thickness appreciably reduces the pressure recovery. This loss may be reduced by increasing the length of the deflectors along the top of the ramp walls.

5. Boundary-layer control

- (a) The use of boundary-layer control needs further investigation. For thin boundary layers the use of deflectors is believed sufficient to insure good pressure recovery.

6. Estimated Mach number effects

- (a) A rough approximation of Mach number effects sufficiently accurate for design purposes may be made by using the low-speed pressure-loss characteristics as effective values which are corrected for Mach number effects.

In order to make the results of this research available in a convenient form, the following design data have been prepared from results obtained by measurements of pressure losses at the duct entrance which may be used to estimate pressure losses at the entrance for submerged entrances with ramp angles up to 10° with divergent ramp walls equivalent to those of divergences 3 and 4 of this report. The losses were measured with lip 6 but may be used with any lip design that does not cause stalling of the internal flow from the inner surface of the upper lip.

Pressure-loss data for the air entering the submerged inlet are given in figure 33 for the basic submerged inlet without deflectors for the thinnest boundary layer which had a total depth of 0.8 of the duct depth.

Figure 34 presents data for the basic duct entrance with normal deflectors with the same boundary layer as for figure 33.

Figure 35 presents data for the basic submerged entrance with extended deflectors for a boundary-layer thickness to duct-depth ratio of 1.2.

Figure 36 presents data for the basic submerged entrance with extended deflectors for a boundary-layer thickness to duct-depth ratio of 1.8.

These data are values determined by integration of contours of pressure loss in the entrance for the average inlet-velocity ratio of the entrance.

Critical-speed characteristics of the lip are given in figure 37 for the lip-angle relation with ramp angle shown.

Design considerations for jet-propelled aircraft. - The design of submerged entries for the airplane of figure 38 is discussed to illustrate the considerations believed necessary for a successful submerged-inlet design. This airplane is powered with a 3000-pound static-thrust jet motor requiring 30.1 pounds of air per second at an airspeed of 550 miles per hour at 25,000 feet altitude. The air enters the jet motor at a velocity of 385 feet per second.

The location of the entrance ahead of the wing on the flat side of the fuselage is desirable because of the thin boundary layer that exists in this region and because the influence of the velocity field of the wing is minimized. In general, it is believed good practice to locate submerged-air inlets in a region of relatively low velocity. The attainment of a high critical speed for the lip is made easier since the incremental velocities are smaller and the initial velocity of the air, which is slowed down on entering the duct, is less than for a high-velocity region, resulting in a less severe pressure gradient and a higher pressure recovery.

The selection of twin entrances located on the sides of the fuselage is dictated by space considerations. It is possible that a single entrance could be placed in the bottom of the fuselage though this is objectionable because stones or debris may be thrown into the entrance by the nose wheel. It should be noted that, for a twin-duct installation, there is danger of flow instability occurring with consequent duct rumble if the inlet-velocity ratio in any flight condition falls below the value for maximum pressure recovery. This condition, when it exists, is usually found in gliding or diving flight with the motor throttled or off. The instability, which consists of flow into one entrance and out of the other, may be eliminated by closing off one entrance in these flight conditions or by making the ramps of the entrances movable so that the entrance area may be reduced and the inlet-velocity ratio increased. The instability may also be removed by providing small spoilers in each duct which are actuated when the throttle is closed or by providing air bleed in the critical flight conditions.

This instability of flow has been found for only twin-duct installations and is a function of the positive variation of pressure recovery with inlet-velocity ratio. Similar instability consisting of flow into one side of the entrance and out of the other, of course, may occur with a single entrance if the total-head pressure distribution across the entrance varies greatly at any inlet-velocity ratio. Such a condition may be eliminated by the proper selection of the entrance location.

The entrance selected for the airplane of figure 38 consists of a 7° ramp with curved divergent walls similar to divergence 4. Lip 6 was used and was given 3° of down incidence. A high-speed inlet-velocity ratio of 0.7 was selected to give high critical speed with good pressure-recovery characteristics. This selection fixed the diffuser expansion at 1.5 to 1.0. Since the boundary-layer thickness calculated by the methods of reference 5 was found to be less than the thinnest boundary tested in the research covered by this report, the data of figure 34 were used to estimate the variation of pressure recovery with inlet-velocity ratio.

Figure 39 shows the variation of the inlet-velocity ratio with airspeed at 25,000 feet altitude. The effective inlet-velocity ratio and the Mach number variation with airspeed also are given.

Figure 40 shows both the estimated pressure losses at the duct entrance for this condition and the total losses to the entrance of the jet motor for an assumed efficiency of the internal ducting of 85 percent.

Field of Use for Submerged Inlets

The results just discussed give some indication of the usefulness of submerged inlets relative to other inlet types. The submerged inlet is essentially a high inlet-velocity-ratio type in contrast to wing-leading-edge and fuselage-nose inlets. This characteristic limits the most efficient use of submerged inlets to internal flow systems which require only a small amount of diffusion, such as the internal ducting for jet motors of the axial-flow type.

Submerged inlets do not appear to have desirable pressure-recovery characteristics for use in supplying air to oil coolers, radiators, or carburetors of conventional reciprocating engines. The required diffusion of the air and the

range of inlet-velocity ratios is too great to give desirable characteristics at all flight conditions. It should be noted also that for jet motors which consume air at low velocity from a plenum chamber, fuselage-nose inlets may prove to be superior to submerged inlets insofar as pressure losses are concerned.

In conclusion, it should be stated that submerged entrances have a definite advantage over other inlet types for certain inlet and air-flow requirements. The design of such inlets is more critical than that of other types because of the effects of boundary-layer thickness and local velocity fields. The design data presented may be used to give an accurate estimate of the characteristics of a submerged-duct entrance which does not depart greatly from those studied herein, provided (1) that the boundary-layer thickness is considered in terms of the duct-entrance depth, and (2) that the inlet-velocity ratio used in estimating characteristics is based on the local velocity over the surface into which the entrance is placed.

CONCLUSIONS

The results of the investigation of submerged air inlets show that

1. High pressure recovery at the submerged entrance may be obtained at inlet-velocity ratios less than unity ($V_A/V_0 \sim 0.7$) for thin boundary layers.
2. The reduction of pressure recovery resulting from thick boundary layers may be minimized by use of deflectors.
3. High critical compressibility speeds ($M_{cr} \sim 0.8$) may be obtained without sacrificing internal-flow characteristics at high inlet-velocity ratios.
4. The variation of pressure recovery and critical speed with angle of attack at constant inlet-velocity ratios for fuselage side entrances is small, a characteristic which makes submerged entrances more desirable than wing-leading-edge inlets for maneuvering aircraft.

Ames Aeronautical Laboratory,
National Advisory Committee for Aeronautics,
Moffett Field, Calif.

~~CONFIDENTIAL~~

REFERENCES

1. Baals, Donald D., Smith, Norman F., and Wright, John B.: The Development and Application of High-Critical-Speed Nose Inlets. NACA ACR No. L5F30a, 1945.
2. Smith, Norman F., and Baals, Donald D.: Wind-Tunnel Investigation of a High-Critical-Speed Fuselage Scoop including the Effects of Boundary Layer. NACA ACR No. L5B01a, 1945.
3. Rogallo, P. M.: Internal-Flow Systems for Aircraft. NACA Rep. No. 713, 1941.
4. von Karman, Th.: Compressibility Effects in Aerodynamics. Jour. Aero. Sci., vol. 8, no. 9, July 1941, pp. 337 - 356.
5. Jacobs, E. N., and von Doenhoff, A. E.: Formulas for Use in Boundary-Layer Calculations on Low- Drag Wings. NACA ACR, Aug. 1941.

5I20

APPENDIX

COEFFICIENTS AND SYMBOLS

| | |
|------------|---|
| x | distance along ramp |
| H | total pressure, lb/sq ft |
| p | static pressure, lb/sq ft |
| V | velocity, ft/sec |
| ρ | air density, slugs/cu ft |
| q | dynamic pressure $(1/2\rho V^2)$, lb/sq ft |
| P | pressure coefficient $(p_1 - p_0)/q_0$ |
| ΔH | loss in total pressure $(H_L - H_0)$, lb/sq ft |
| η | ducting efficiency |
| η_D | diffuser efficiency factor $1 - (\Delta H_D/q_A)$ |
| M | Mach number |
| M_{cr} | critical Mach number |
| α | angle of attack of model wing, deg |

Subscripts

| | |
|----|--|
| A | station at the duct entrance |
| L | station at which the pressure measurements were made |
| o | free stream |
| av | average over duct section |
| D | diffuser |
| c | compressible |
| i | incompressible |

~~CONFIDENTIAL~~

TABLE I.- ORDINATES FOR DIVERGENT RAMP WALLS

| x/λ \ y/b | Divergence 0 | Divergence 1 | Divergence 2 | Divergence 3 | Divergence 4 |
|---------------------|--------------|--------------|--------------|--------------|--------------|
| 0 | 0.50 | 0.500 | 0.500 | 0.5000 | 0.5000 |
| .5 | .50 | .500 | .500 | .5000 | .4930 |
| .10 | .50 | .500 | .500 | .5000 | .4670 |
| .20 | .50 | .470 | .458 | .4470 | .3870 |
| .30 | .50 | .442 | .415 | .4000 | .3100 |
| .40 | .50 | .418 | .373 | .3500 | .2420 |
| .50 | .50 | .390 | .333 | .3050 | .1950 |
| .60 | .50 | .363 | .290 | .2550 | .1550 |
| .70 | .50 | .355 | .250 | .2080 | .1200 |
| .80 | .50 | .308 | .205 | .1580 | .0750 |
| .90 | .50 | .280 | .165 | .1100 | .0575 |
| 1.00 | .50 | .250 | .125 | .0625 | .0440 |

Note: Reference axes are shown on figure 6.

TABLE II(a).- LIP ORDINATES GIVEN IN INCHES

| Sta- tion | Lip 1 | | Lip 2 | | Lip 3 | | Lip 4 | | Lip 5 | | Lip 6 | | Lip 7 | |
|--------------|-----------------------|--------|-----------------------|--------|-----------------------|--------|-----------------------|--------|-----------------------|--------|-----------------------|--------|------------------------|--------|
| | Upper | Lower | Upper | Lower | Upper | Lower | Upper | Lower | Upper | Lower | Upper | Lower | Upper | Lower |
| 0 | -0.125 | -0.125 | -0.125 | -0.125 | -0.220 | -0.220 | -0.125 | -0.125 | -0.125 | -0.125 | -0.063 | -0.063 | -0.063 | -0.063 |
| .25 | 0 | -.265 | 0 | -.320 | -.030 | -.360 | .065 | -.310 | .065 | -.280 | .100 | -.275 | .160 | -.280 |
| .50 | 0 | -.296 | 0 | -.380 | 0 | -.390 | .115 | -.370 | .115 | -.350 | .150 | -.350 | .210 | -.360 |
| .75 | 0 | -.336 | 0 | -.415 | 0 | -.421 | .125 | -.410 | .125 | -.395 | .175 | -.410 | .230 | -.410 |
| 1.00 | 0 | -.367 | 0 | -.440 | 0 | -.451 | .120 | -.440 | .120 | -.440 | .187 | -.440 | .250 | -.440 |
| 1.50 | 0 | -.428 | 0 | -.501 | 0 | -.512 | .110 | -.500 | .110 | -.501 | .187 | -.505 | .240 | -.505 |
| 2.00 | 0 | -.488 | 0 | -.563 | 0 | -.574 | .100 | -.560 | .100 | -.562 | .175 | -.570 | .220 | -.570 |
| 2.50 | 0 | -.550 | 0 | -.624 | 0 | -.635 | .085 | -.622 | .085 | -.623 | .150 | -.631 | .180 | -.631 |
| 3.00 | 0 | -.611 | 0 | -.685 | 0 | -.696 | .060 | -.683 | .060 | -.685 | .120 | -.692 | .150 | -.693 |
| 3.50 | 0 | -.673 | 0 | -.746 | 0 | -.757 | .030 | -.745 | .030 | -.746 | .085 | -.753 | .110 | -.754 |
| 4.00 | 0 | -.734 | 0 | -.807 | 0 | -.818 | 0 | -.806 | 0 | -.808 | .055 | -.815 | .060 | -.815 |
| 4.50 | 0 | -.795 | 0 | -.869 | 0 | -.880 | 0 | -.867 | 0 | -.869 | 0 | -.877 | 0 | -.877 |
| | L.E. radius: 0.125 | | L.E. radius: 0.125 | | L.E. radius: 0.125 | | L.E. radius: 0.125 | | L.E. radius: 0.075 | | L.E. radius: 0.125 | | L.E. radius: 0.1875 | |

Note: For location of reference line, see figure 15(b).

CONFIDENTIAL

TABLE II(b).- ORDINATES FOR SUBMERGED
LIP 6 IN INCHES

| Station | Outer surface | Inner surface |
|---------|---------------|---------------|
| 0 | -0.240 | -0.240 |
| .25 | -.087 | -.462 |
| .50 | -.037 | -.537 |
| .75 | -.012 | -.597 |
| 1.00 | 0 | -.627 |
| 1.50 | 0 | -.692 |
| 2.00 | 0 | -.757 |
| 2.50 | 0 | -.819 |
| 3.00 | 0 | -.879 |
| 3.50 | 0 | -.940 |
| 4.00 | 0 | -1.002 |
| 4.50 | 0 | -1.064 |

Leading-edge radius = 0.125

Note: For location of reference line,
see figure 15(b).

TABLE III - CRITICAL MACH NUMBERS AND AVERAGE DUCT-ENTRANCE LOSSES FOR VARIOUS LIP PROFILES THROUGHOUT THE INLET-VELOCITY-RATIO RANGE

| VA/V ₀ | Lip 1 | | Lip 2 | | Lip 3 | | Lip 4 | | Lip 5 | | Lip 6 | | Lip 7 | |
|-------------------|-----------------|------------------------------|-----------------|------------------------------|-----------------|------------------------------|-----------------|------------------------------|-----------------|------------------------------|-----------------|------------------------------|-----------------|------------------------------|
| | M _{cr} | $\frac{\Delta H_{Aav}}{q_A}$ | M _{cr} | $\frac{\Delta H_{Aav}}{q_A}$ | M _{cr} | $\frac{\Delta H_{Aav}}{q_A}$ | M _{cr} | $\frac{\Delta H_{Aav}}{q_A}$ | M _{cr} | $\frac{\Delta H_{Aav}}{q_A}$ | M _{cr} | $\frac{\Delta H_{Aav}}{q_A}$ | M _{cr} | $\frac{\Delta H_{Aav}}{q_A}$ |
| 0 | --- | --- | 0.54 | --- | 0.57 | --- | 0.56 | --- | 0.53 | --- | 0.63 | --- | 0.54 | --- |
| .5 | 0.420 | 0.542 | .64 | 0.542 | .73 | 0.444 | .71 | 0.508 | .69 | 0.650 | .80 | 0.425 | .63 | 0.692 |
| .7 | .161 | .127 | .69 | .127 | .68 | .117 | .77 | .131 | .77 | .135 | .89 | .113 | .69 | .150 |
| .8 | .086 | .079 | .62 | .079 | .69 | .064 | .80 | .075 | .80 | .074 | .93 | .063 | .72 | .085 |
| 1.0 | .048 | .048 | .45 | .048 | .51 | .032 | .62 | .038 | .72 | .043 | .71 | .036 | .75 | .040 |
| 1.2 | .028 | .024 | .40 | .024 | .44 | .021 | .50 | .023 | .58 | .016 | .57 | .020 | .61 | .023 |
| 1.5 | .069 | .015 | --- | .015 | --- | .087 | .36 | .009 | .48 | .012 | .45 | .013 | .50 | .014 |
| 2.0 | Stalled | .007 | --- | .007 | --- | .190 | --- | .007 | --- | .006 | --- | .004 | --- | .007 |
| 2.5 | Stalled | .005 | --- | .005 | --- | .312 | --- | .004 | --- | .005 | --- | .004 | --- | .006 |
| 3.0 | Stalled | .002 | --- | .002 | --- | .433 | --- | .002 | --- | .004 | --- | .003 | --- | .005 |
| 4.0 | Stalled | .002 | --- | .002 | --- | .450 | --- | .001 | --- | .003 | --- | .002 | --- | .005 |
| ∞ | Stalled | .452 | --- | .452 | --- | .464 | --- | .425 | --- | .440 | --- | .000 | --- | .000 |

CONFIDENTIAL

CONFIDENTIAL

- 1 75 HP BLOWER
- 2 15 HP BLOWER
- 3 BUTTERFLY VALVE
- 4 VENTURY METER
- 5 3" IN-TAKE AIR DUCT
- 6 ENTRANCE BELL
- 7 SUBMERGED DUCT ENTRANCE
- 8 FALSE FLOOR
- 9 TEST SECTION
- 10 ENTRANCE PUMP
- 11 PAKE OF TOTAL PRESSURE TUBES
- 12 BOUNDARY LAYER SUMP
- 13 DIFFUSER
- 14 BOUNDARY LAYER AIR DUCT

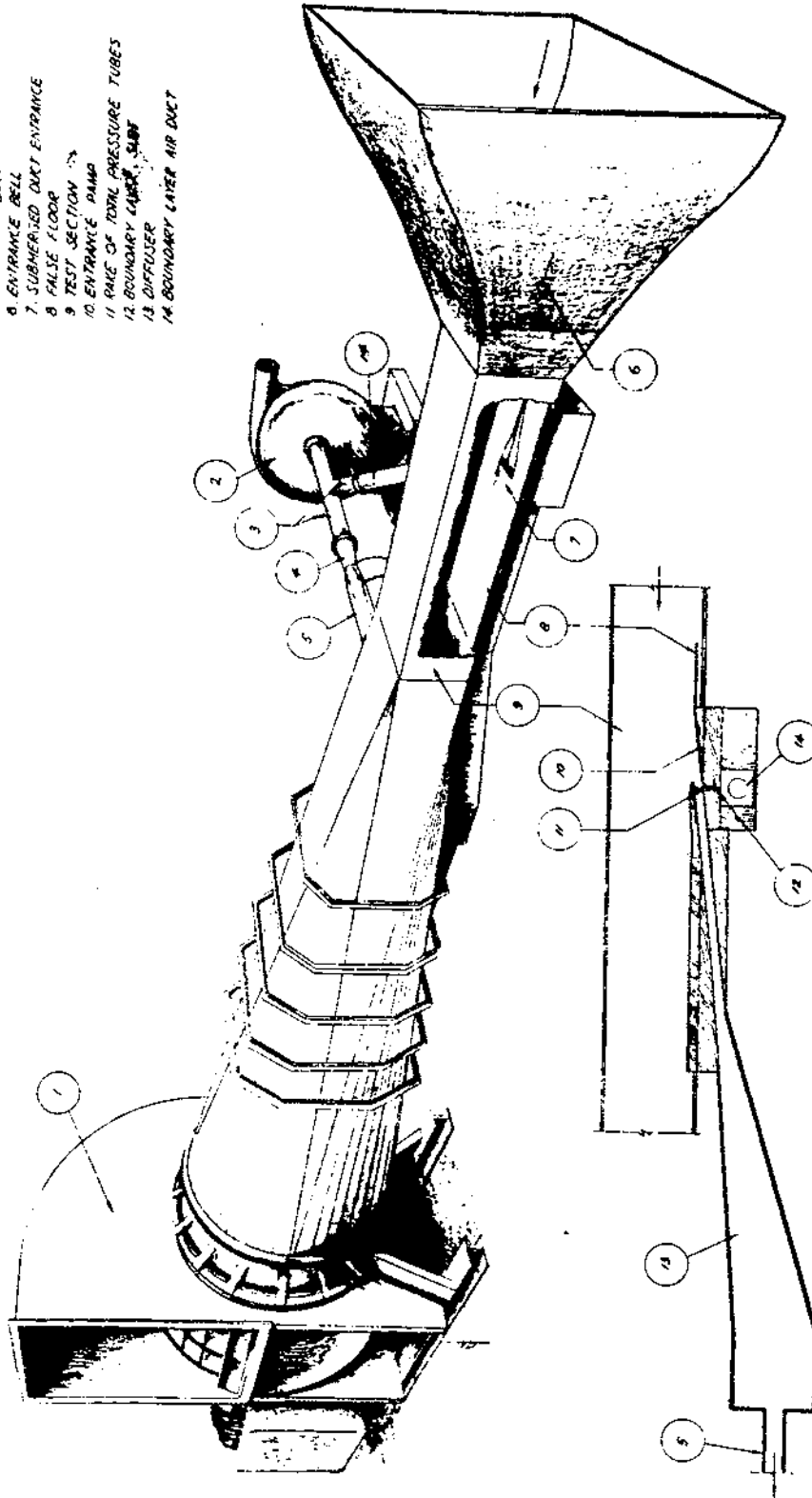

NACA
A-7935
3-22-45

Figure 1.- 1- by 1-1/2-foot wind channel as arranged for submerged-duct-entrance tests.

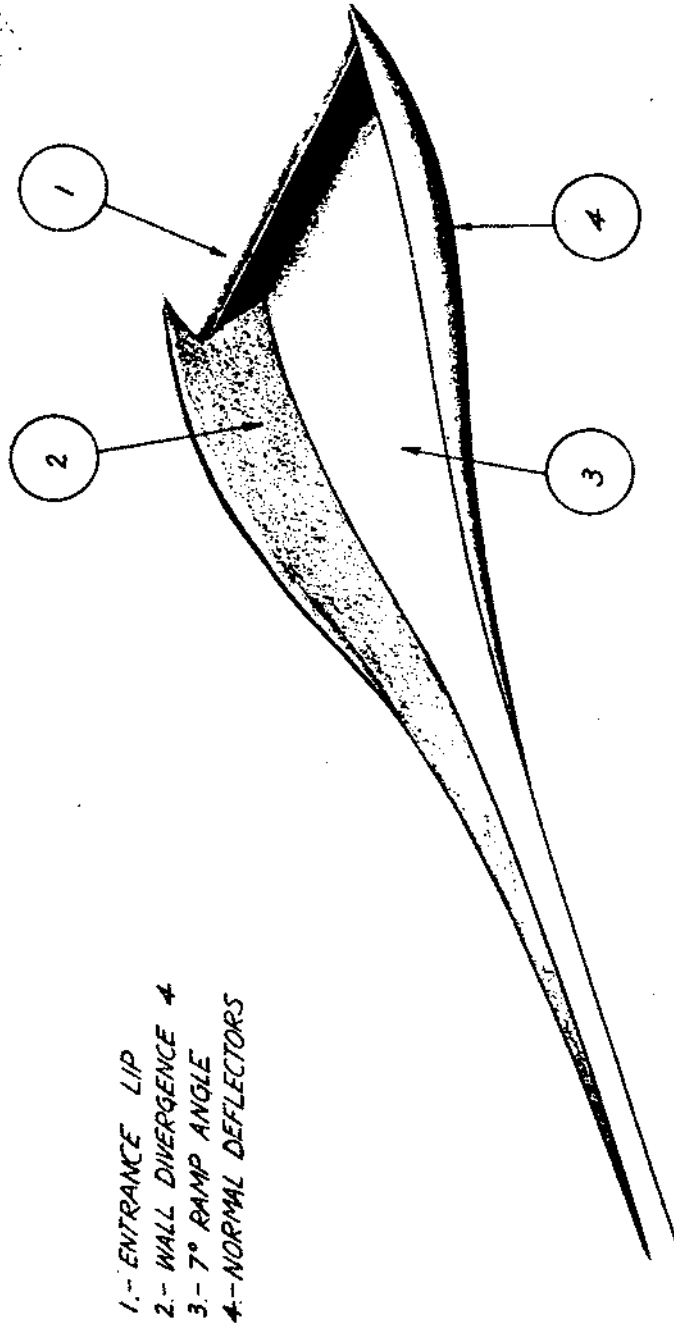

- 1.- ENTRANCE LIP
- 2.- WALL DIVERGENCE
- 3.- 7° RAMP ANGLE
- 4.- NORMAL DEFLECTORS

NACA
ACR 5120
4-72-45

Figure 2.- Sketch of submerged-duct entrance.

CONFIDENTIAL

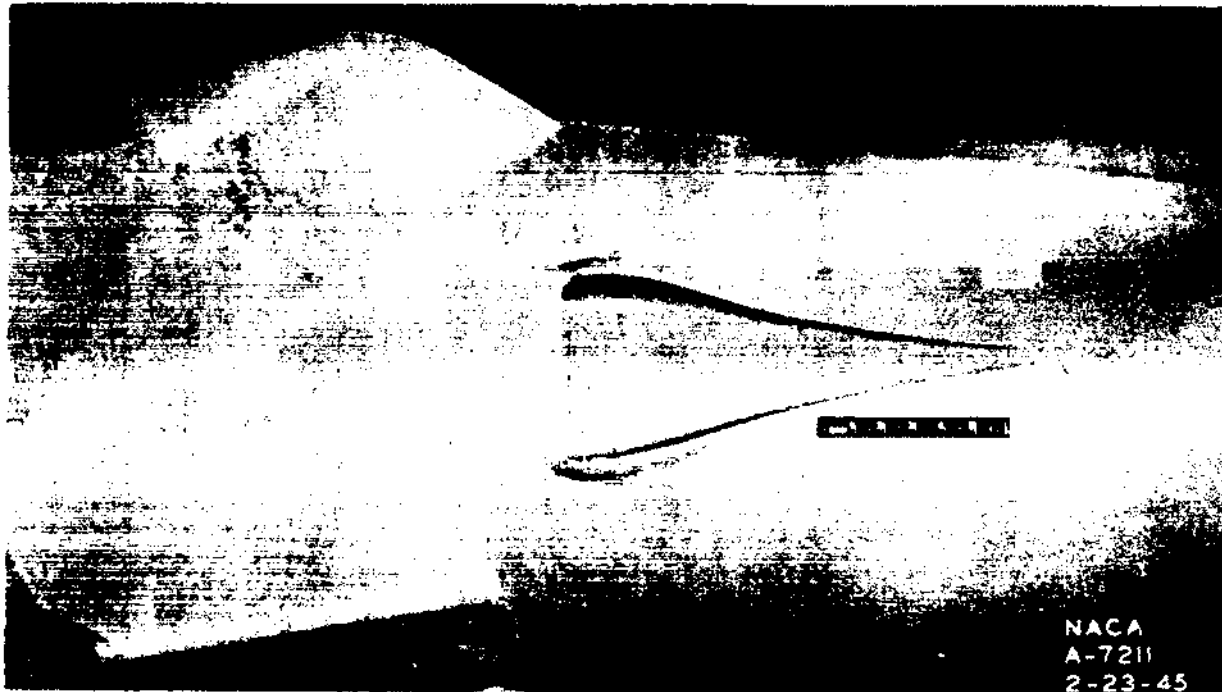

(a) View with normal deflectors.

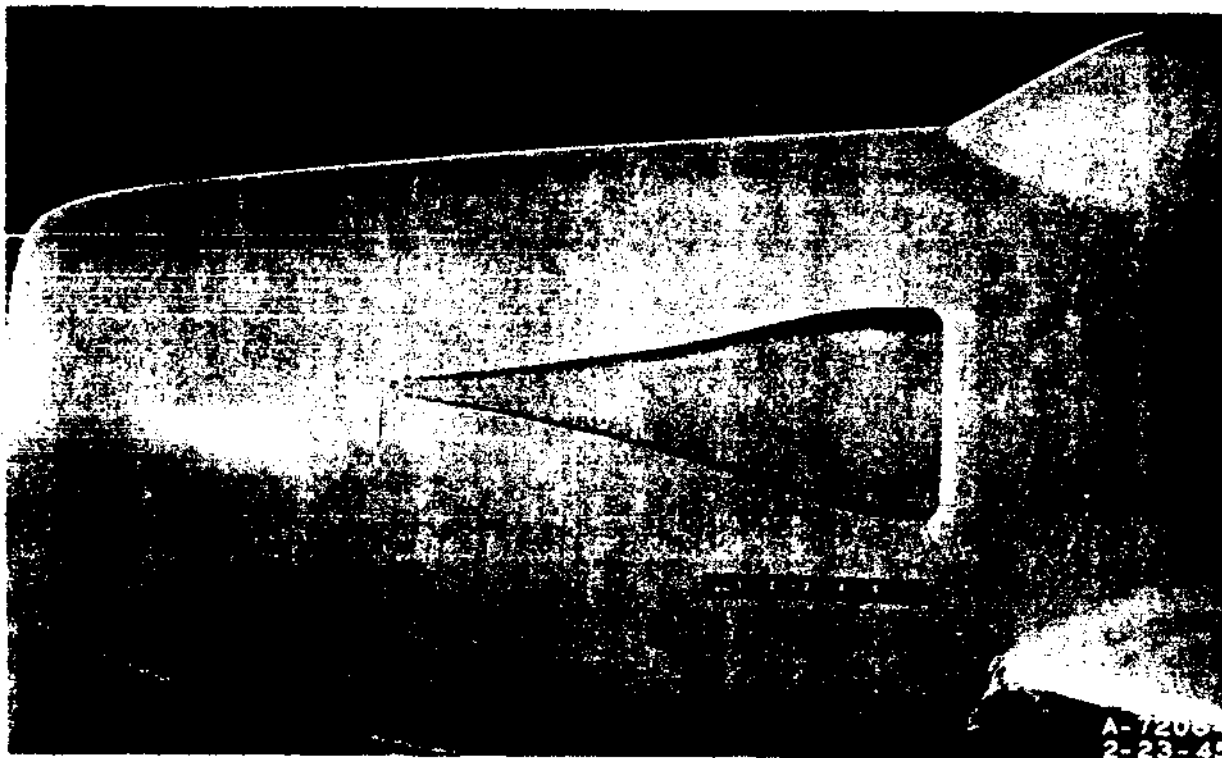

(b) View without deflectors.

Figure 3.- Submerged-duct installation on a 0.25-scale model of a fighter airplane.

~~CONFIDENTIAL~~

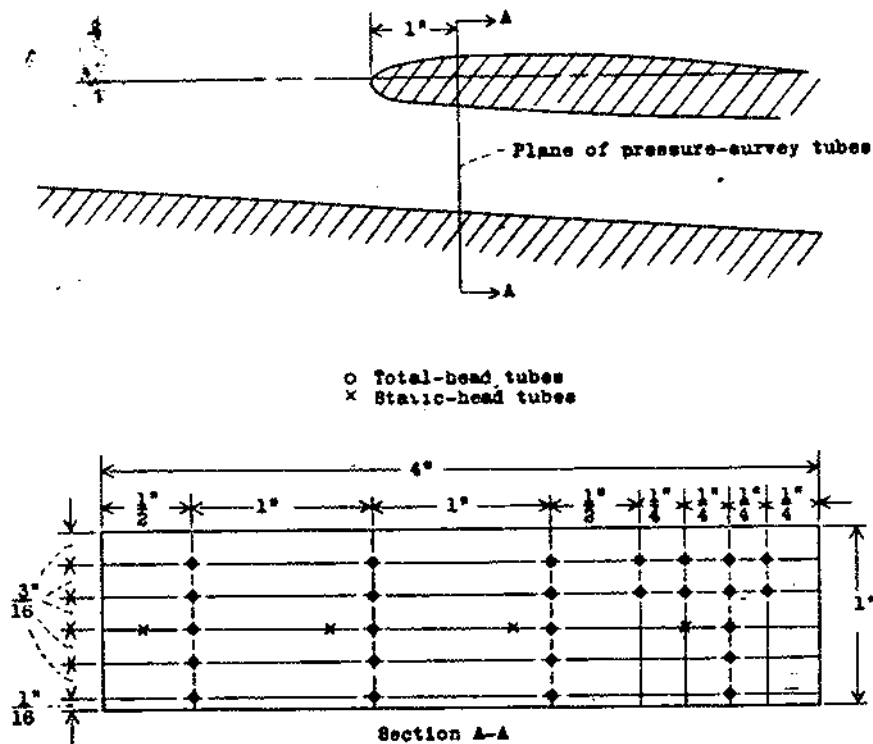

Figure 4.- Location of pressure-survey tubes in the entrance of the submerged-duct entry.

NATIONAL ADVISORY COMMITTEE
FOR AERONAUTICS

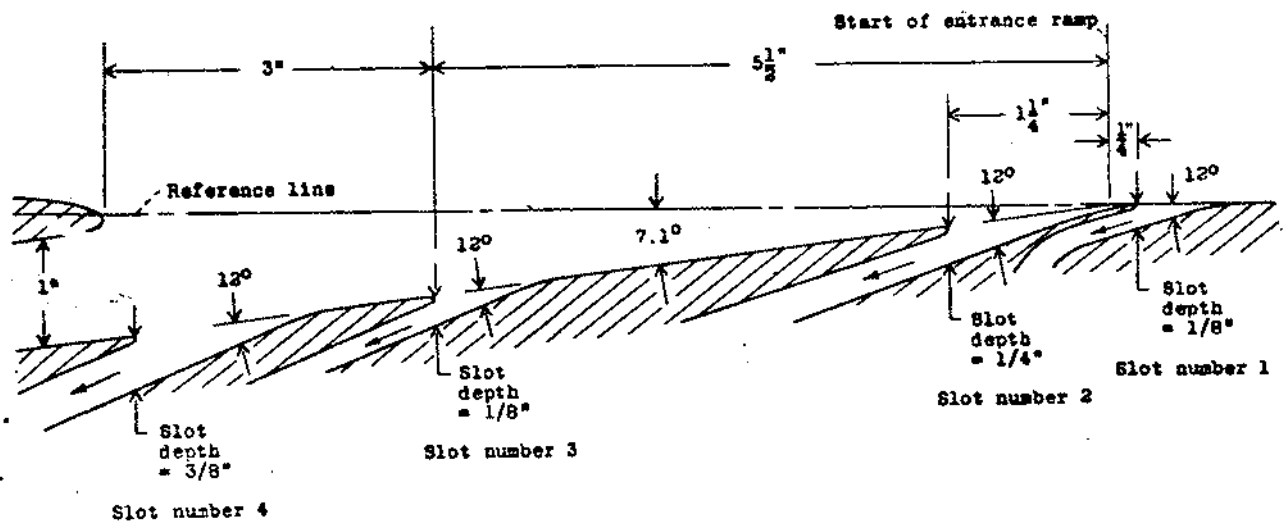
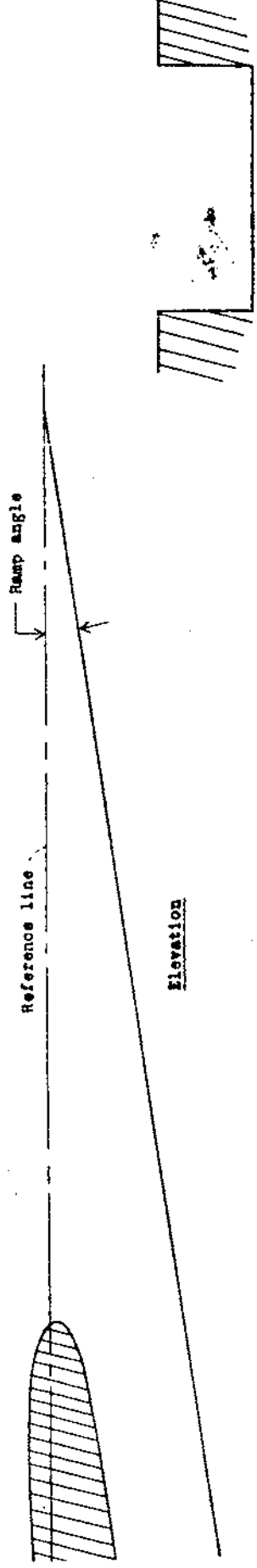

Figure 5.- Sectional view of submerged-duct entry showing boundary-layer-control slots tested.



NATIONAL ADVISORY COMMITTEE FOR AERONAUTICS

Section A-A of divergent ramp 4

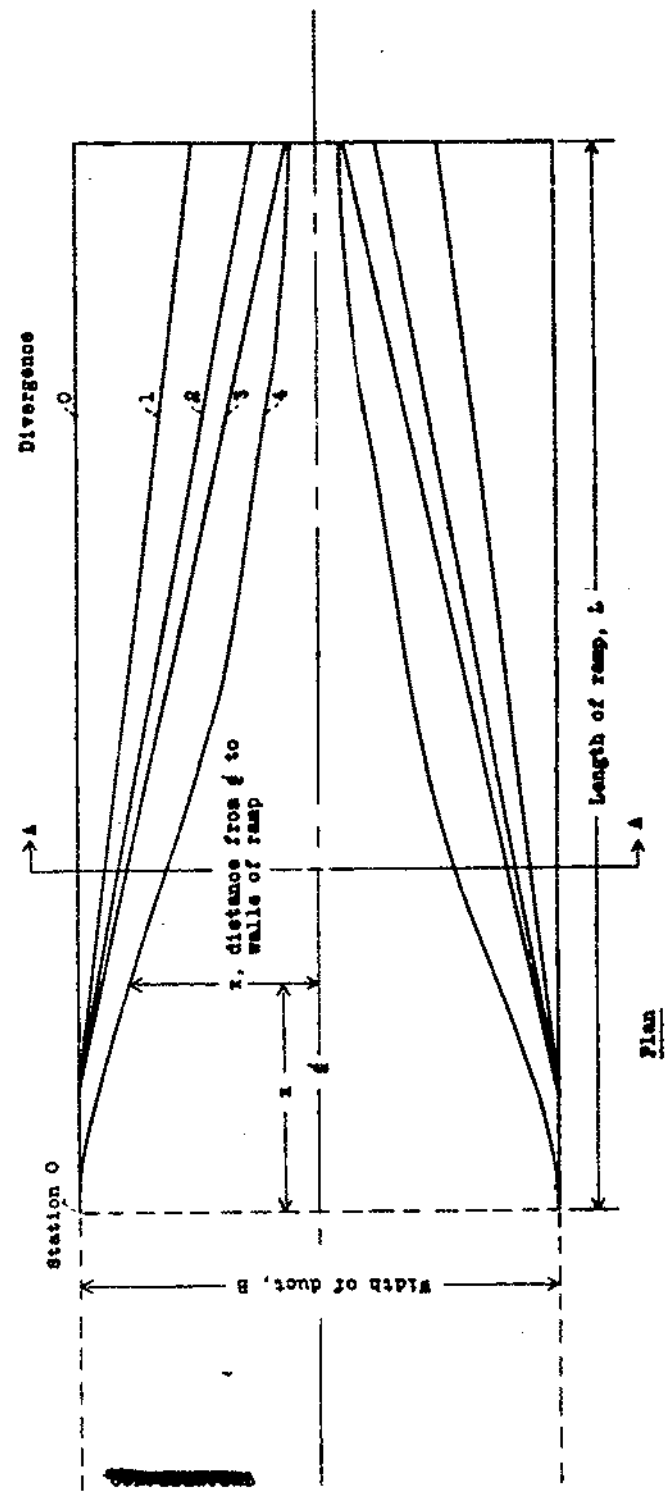

Figure 6.- The divergent ramp walls tested with various ramp angles.

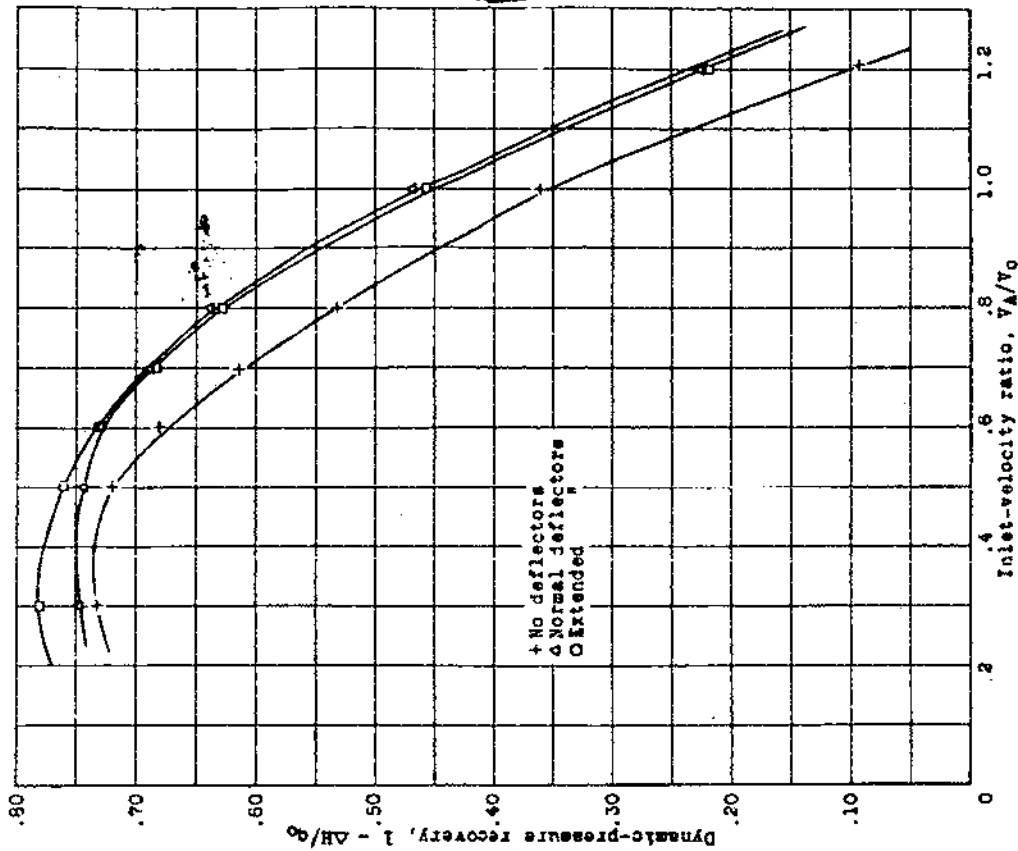

Figure 10.- The variation of dynamic-pressure recovery after diffusion with inlet-velocity ratio for various deflectors; 70 ramp angle; boundary layer 1; lip 6.

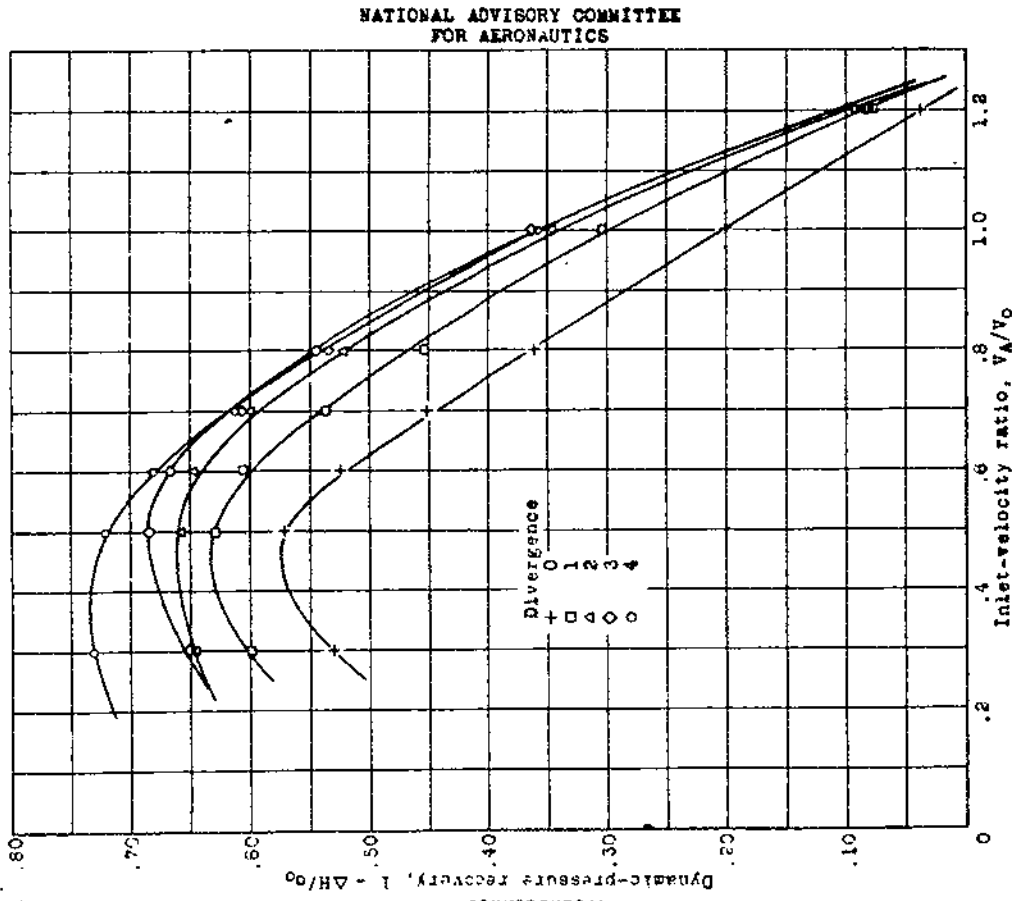
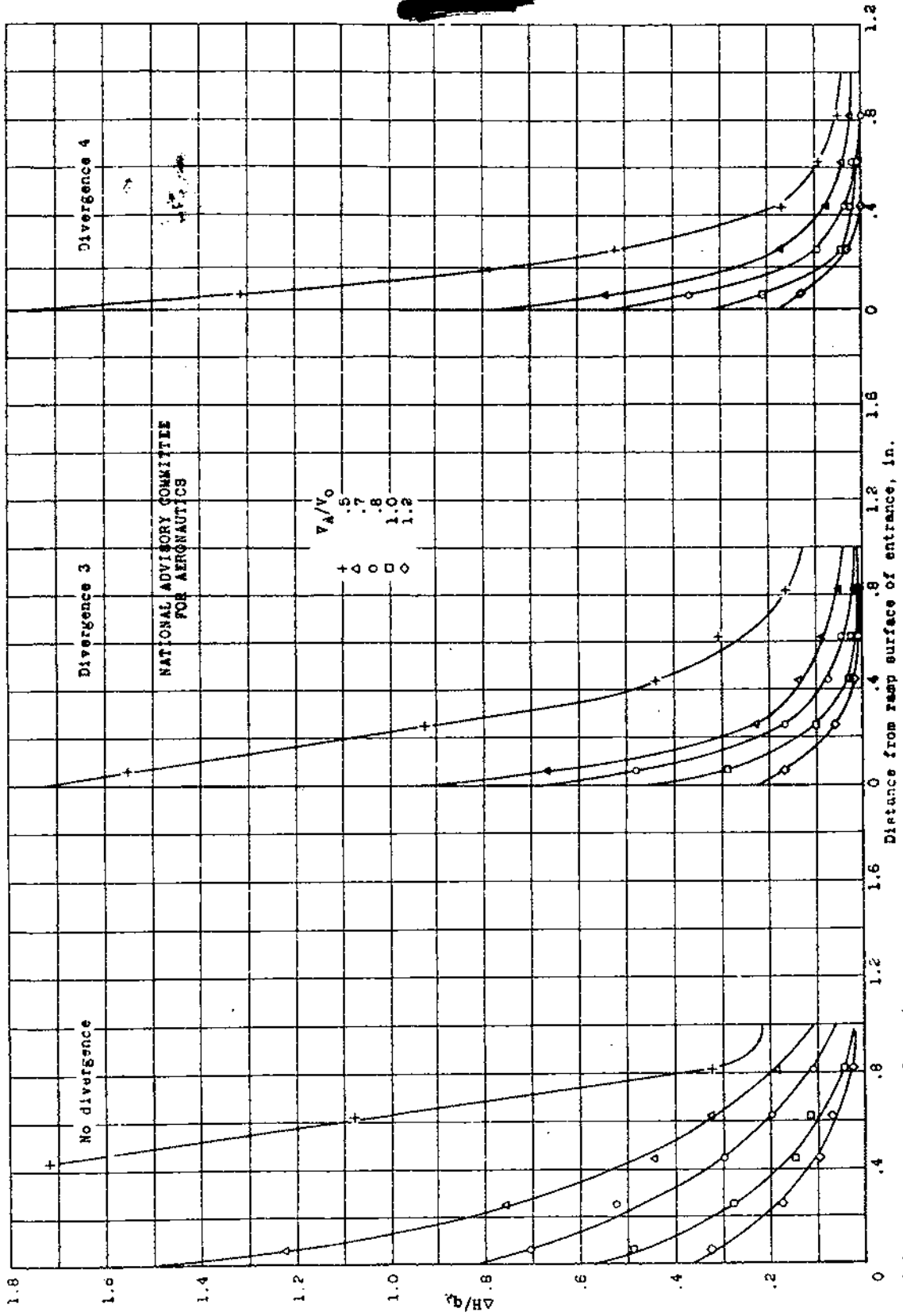

Figure 7.- The variation of dynamic-pressure recovery after diffusion with inlet-velocity ratio for diverging ramp walls, 70 ramp angle; boundary layer 1; lip 6.

NATIONAL ADVISORY COMMITTEE
FOR AERONAUTICS



(a) Losses at center of opening.

Figure 8a, b. - Pressure-loss distribution in the entrance of the submerged inlet with various divergent walls; 7° ramp angle; boundary layer 1; lip b.

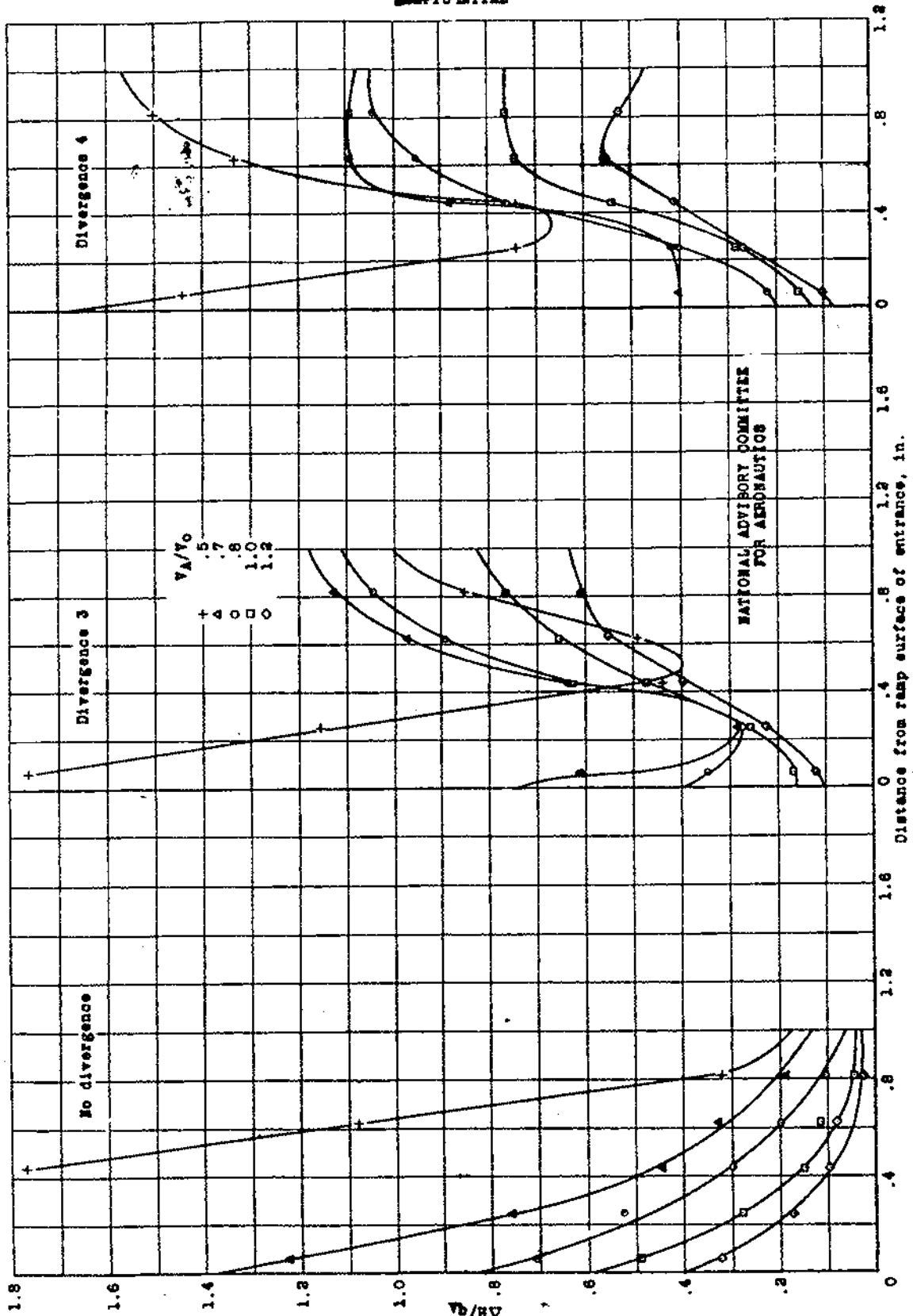

(b) Losses at sides of opening.

Figure 8.- Concluded.

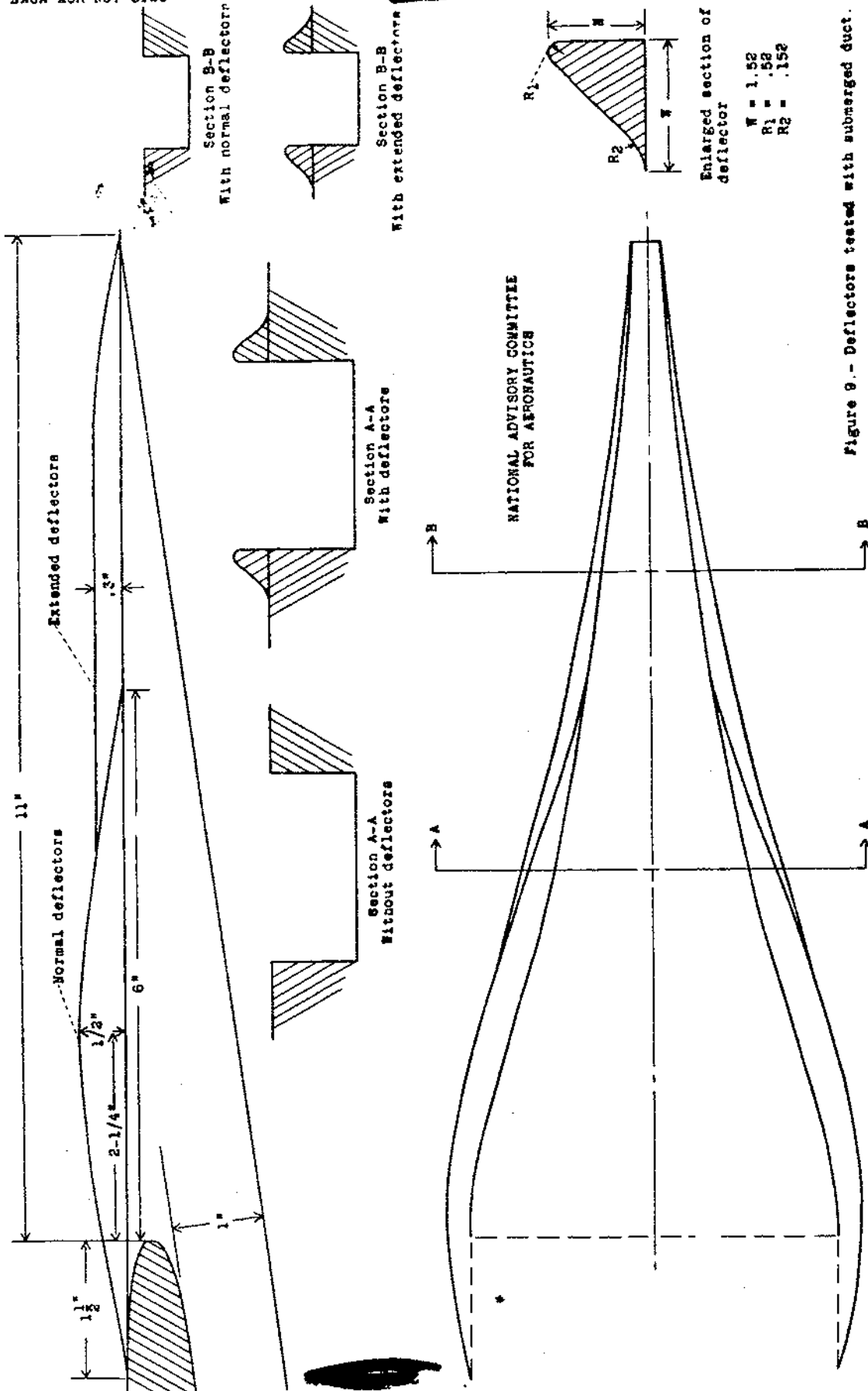

Fig. 9

Figure 9. - Deflectors tested with submerged duct.

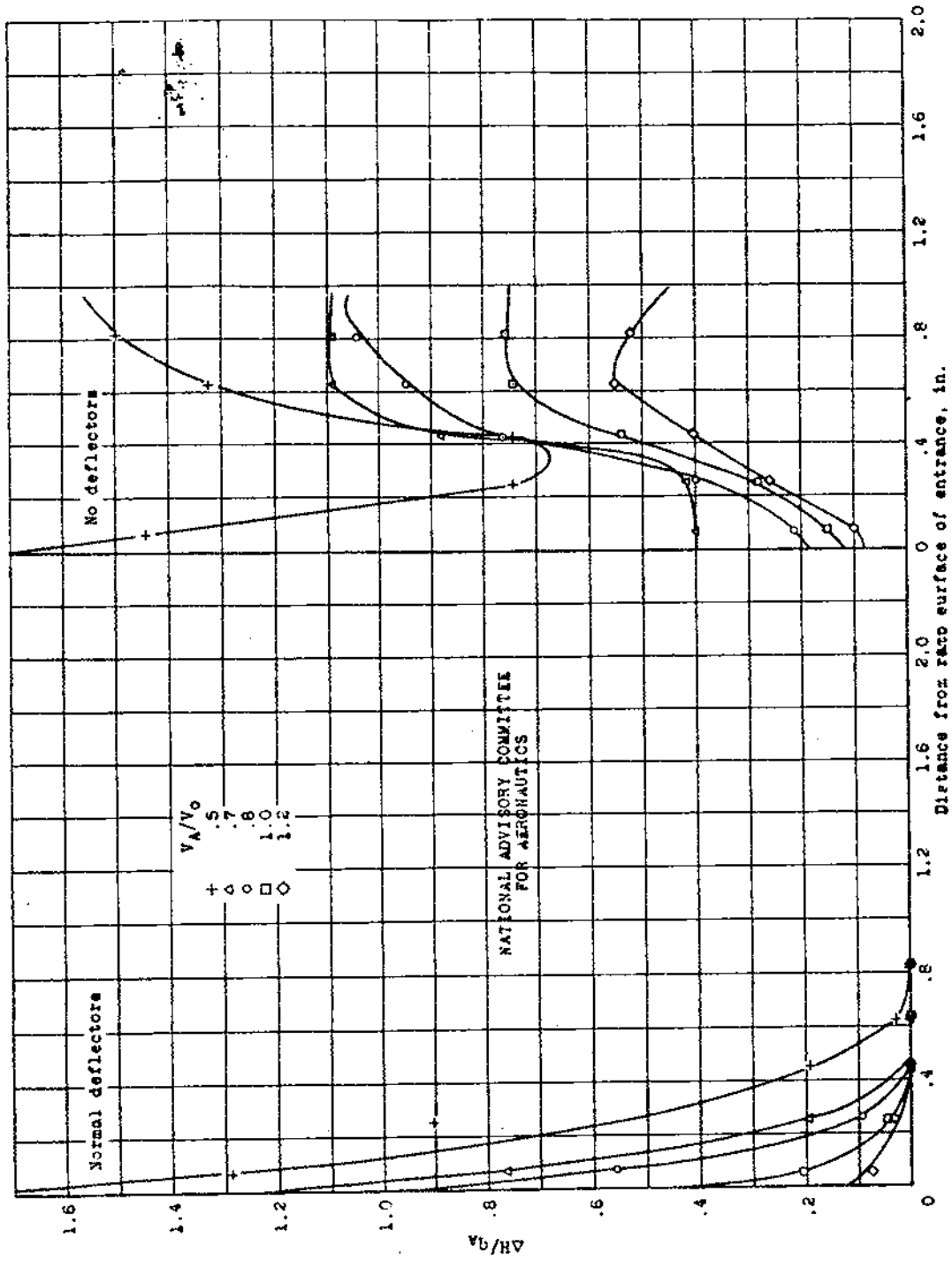

Figure 11.- Pressure losses at the sides of the submerid-duct entrance with normal deflectors and without deflectors; 70 ramp angle; boundary layer 1; lip δ ; divergence 4.

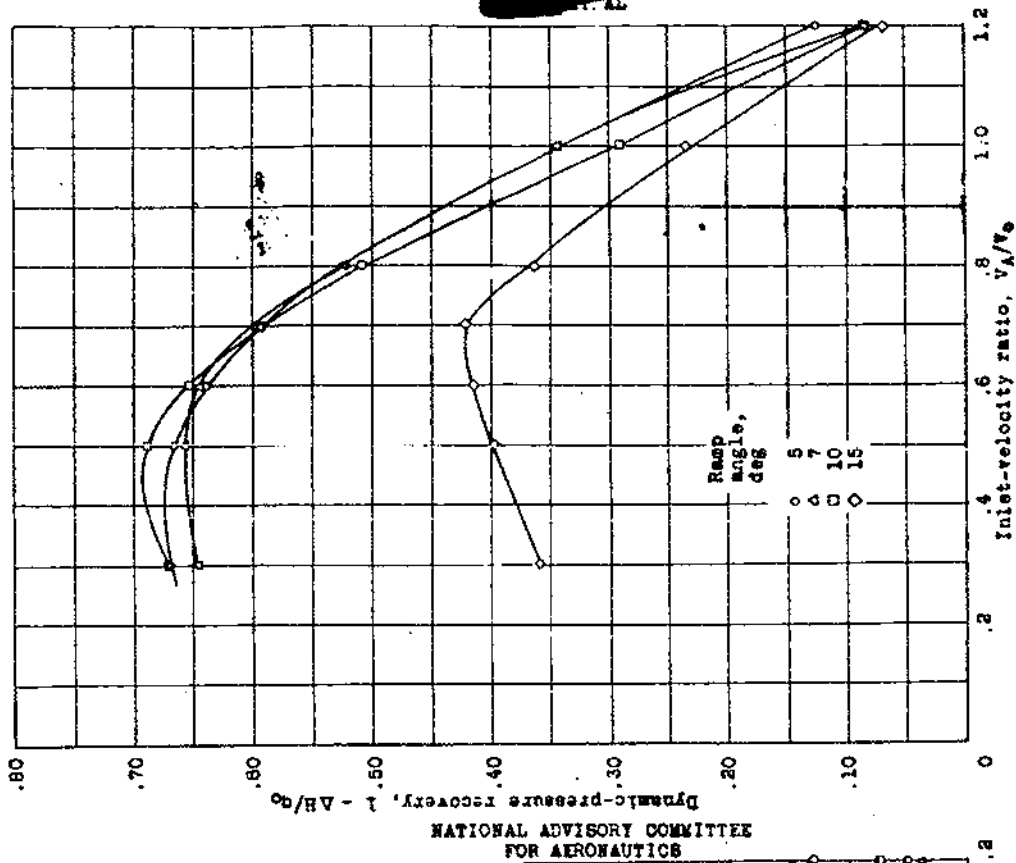

Figure 12.- The variation of dynamic-pressure recovery after diffusion with inlet-velocity ratio for various ramp angles and ∞ divergence; boundary layer 1; lip 6.

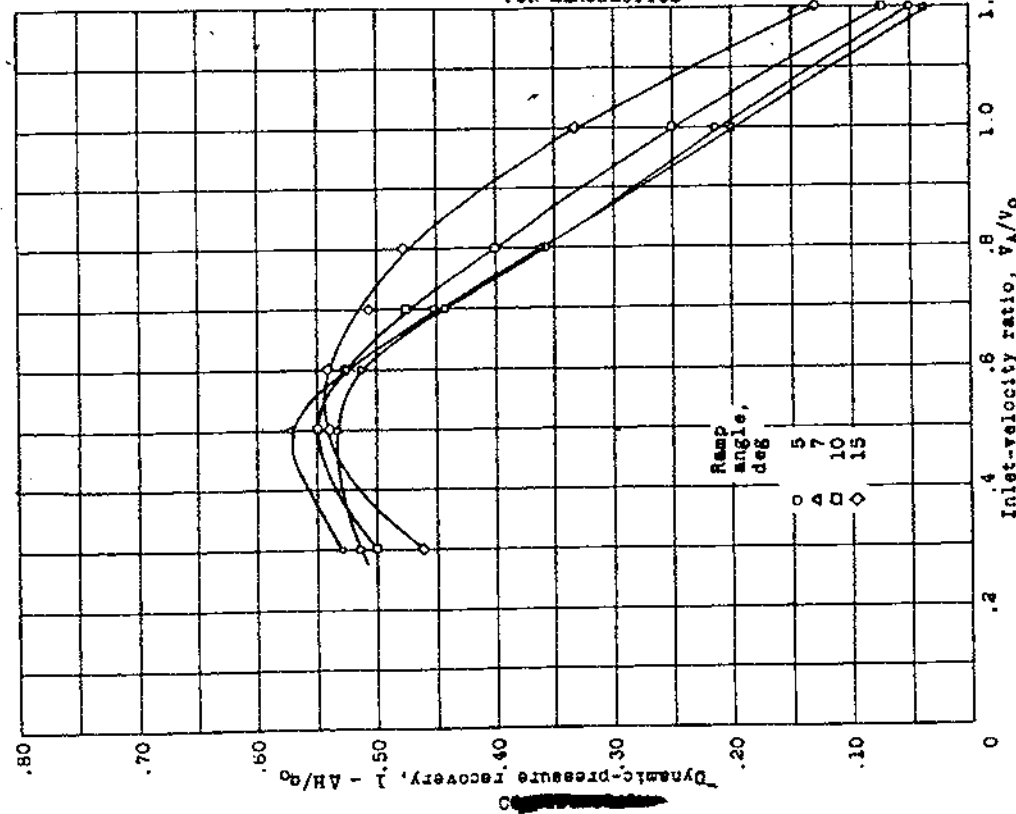

Figure 13.- The variation of dynamic-pressure recovery after diffusion with inlet-velocity ratio for various ramp angles and diverging wall; boundary layer 2; lip 6.

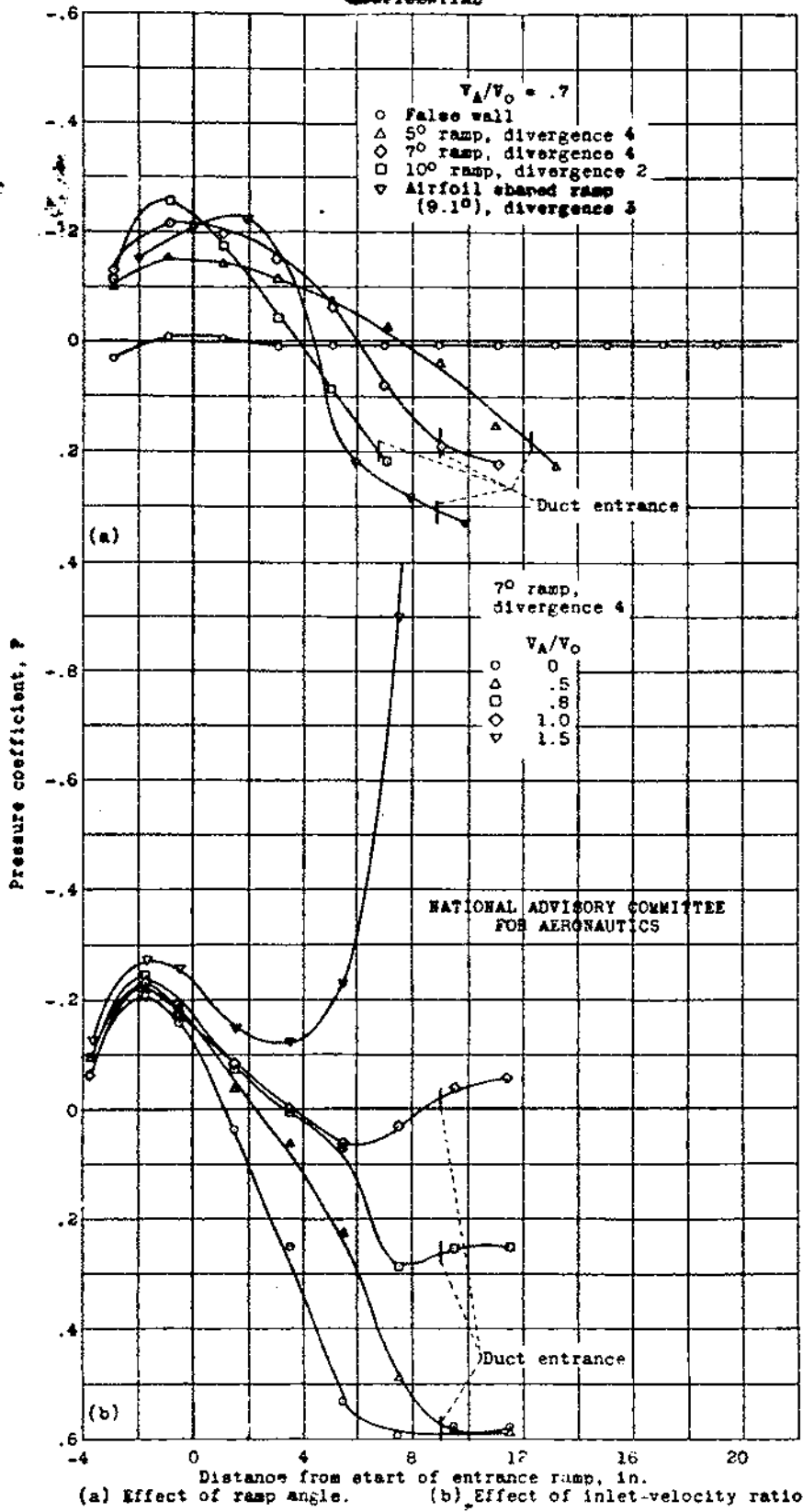
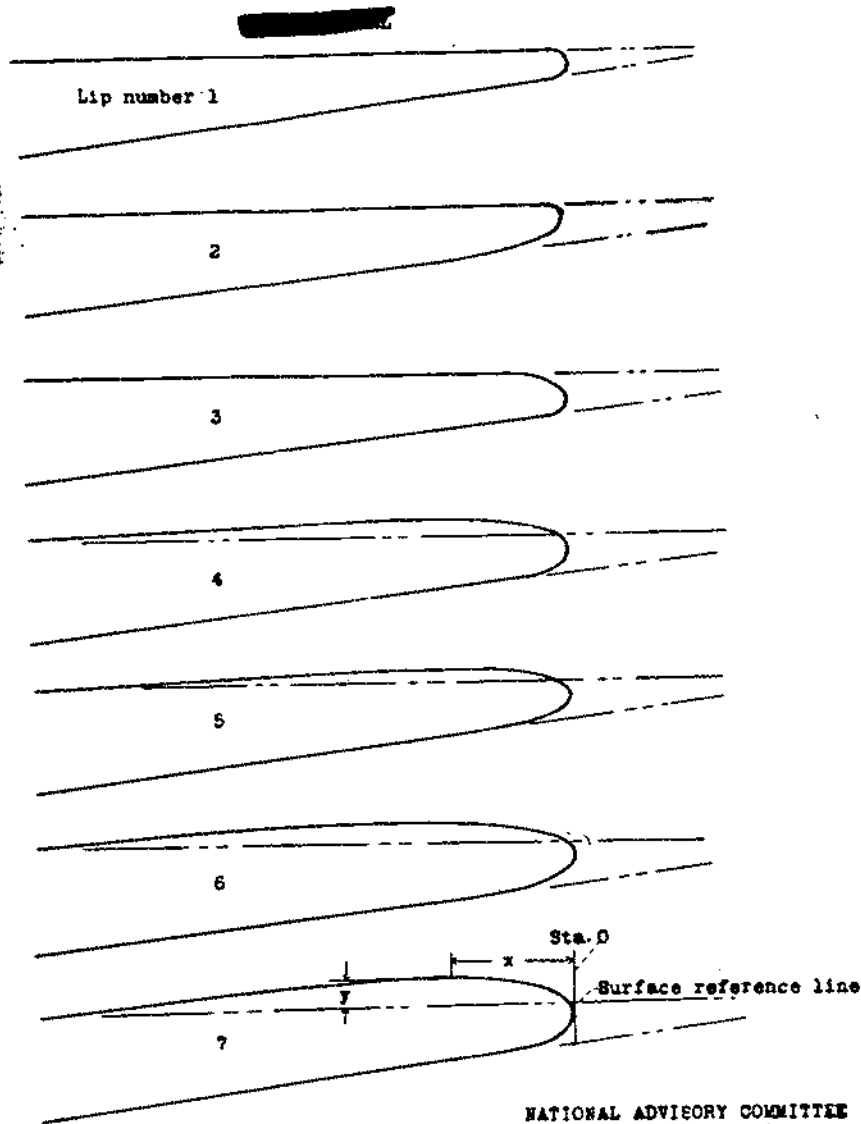
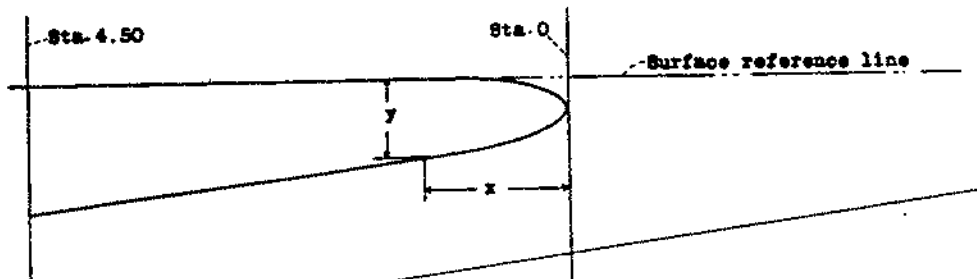

Figure 14.- The pressure gradient along the ramp floor.



NATIONAL ADVISORY COMMITTEE
FOR AERONAUTICS

(a) Normal lips



(b) Submerged lip*

Figure 15.- Lip shapes tested with the submerged duct.

~~CONFIDENTIAL~~

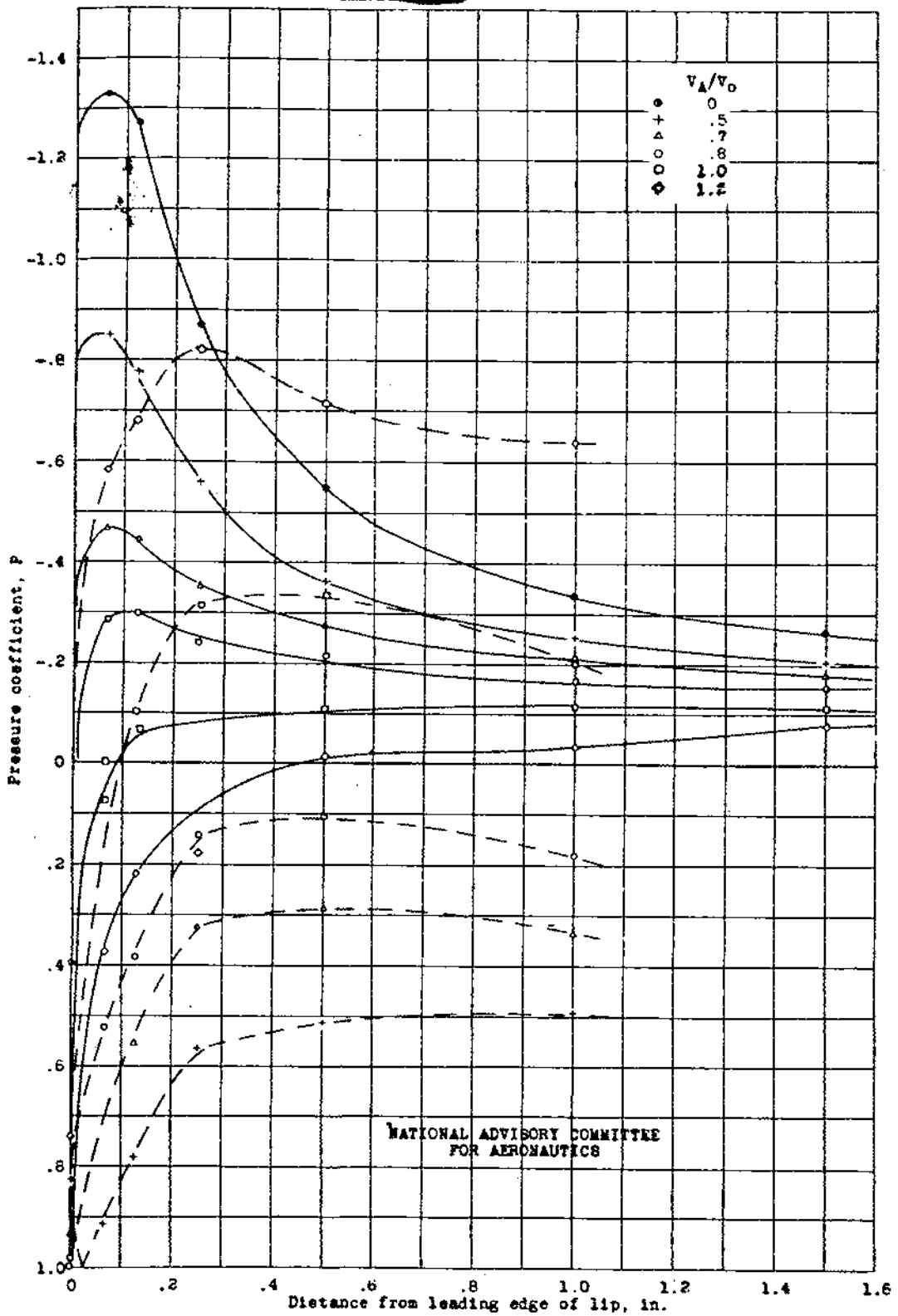

Figure 16.- Pressure distribution for various inlet-velocity ratios with lip 6 at zero incidence for a 70° ramp angle; boundary layer 1.

C

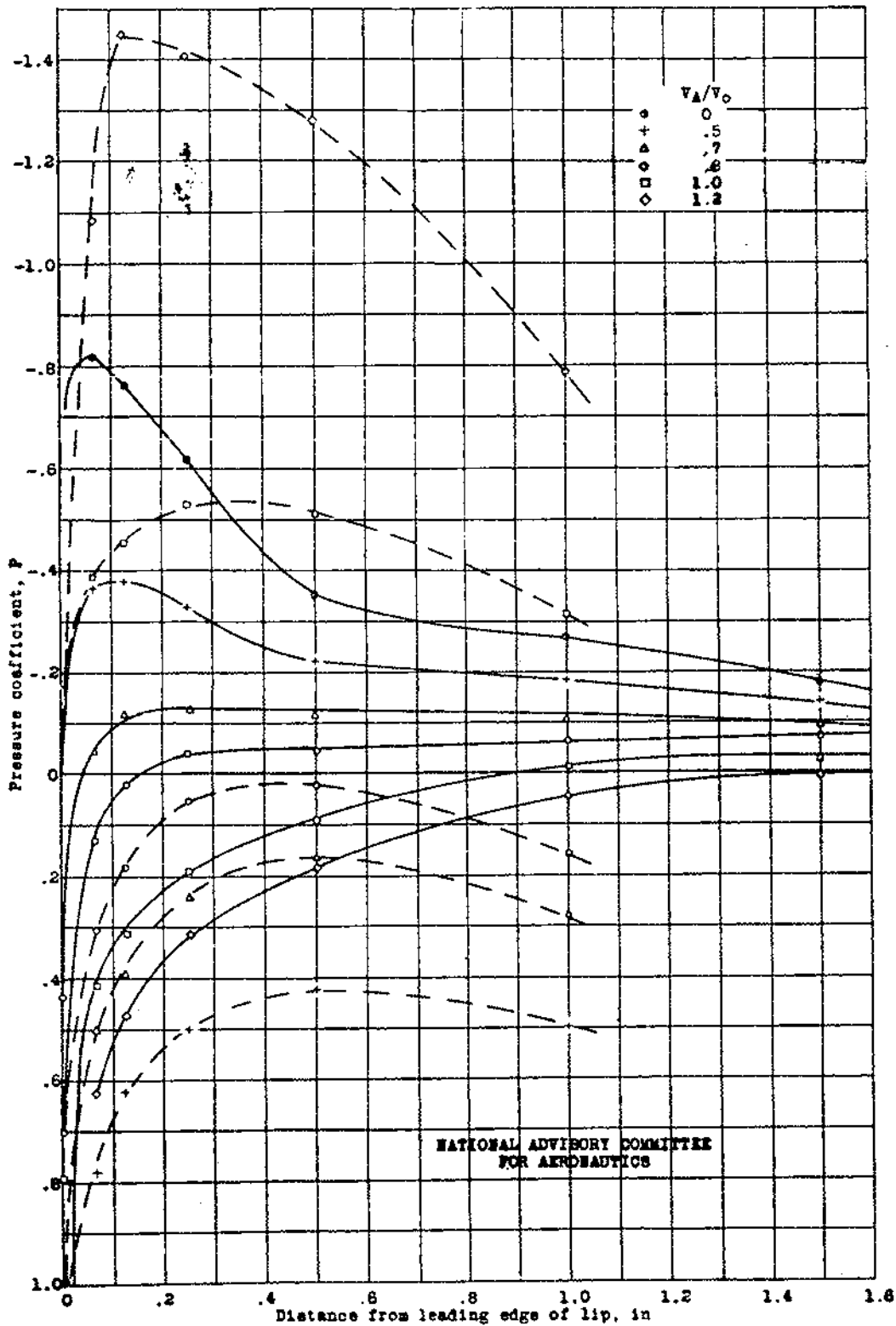
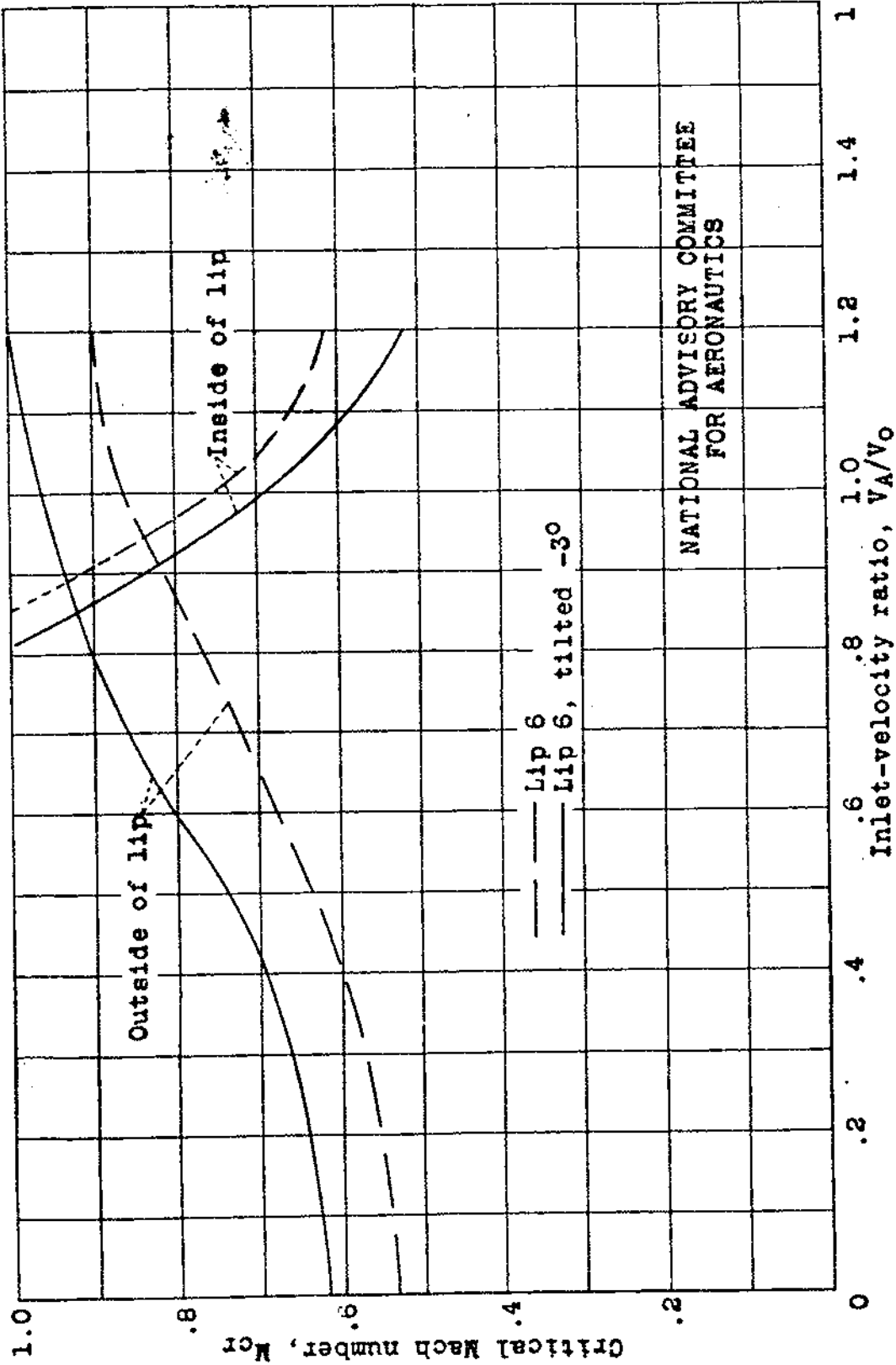

Figure 17.- Pressure distribution for various inlet-velocity ratios with lip 8 at -30° incidence; 7° ramp angle; boundary layer 1.

~~CONFIDENTIAL~~



NATIONAL ADVISORY COMMITTEE
FOR AERONAUTICS

Figure 18.- The variation of critical Mach number with inlet-velocity ratio for lip 6 at 0° and -30° incidence; 7° ramp angle; boundary layer 1; divergence 4.

~~CONFIDENTIAL~~

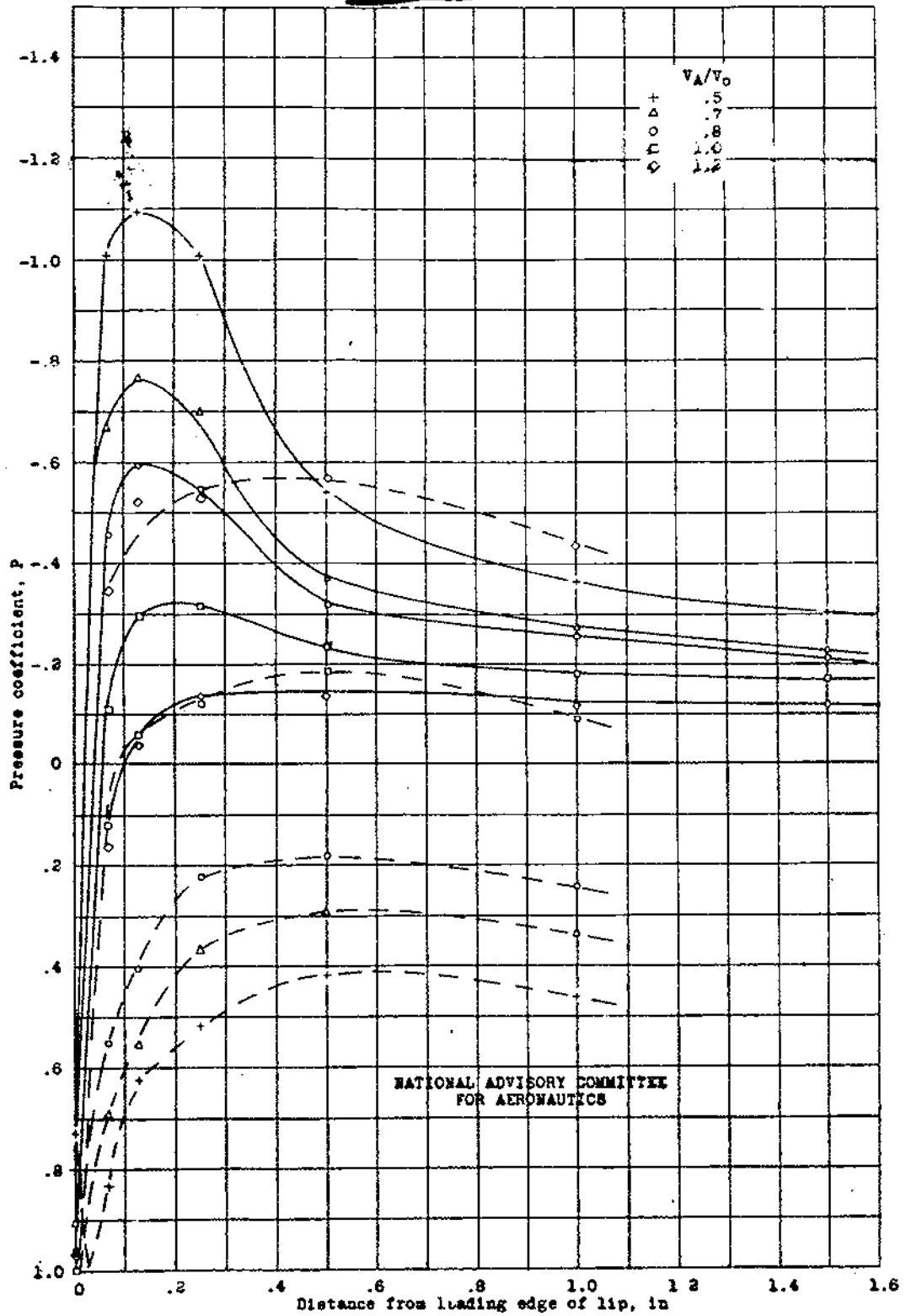

Figure 19.- Pressure distribution for various inlet-velocity ratios with lip 6 at zero incidence for a 5° ramp angle; boundary layer 1.

~~CONFIDENTIAL~~

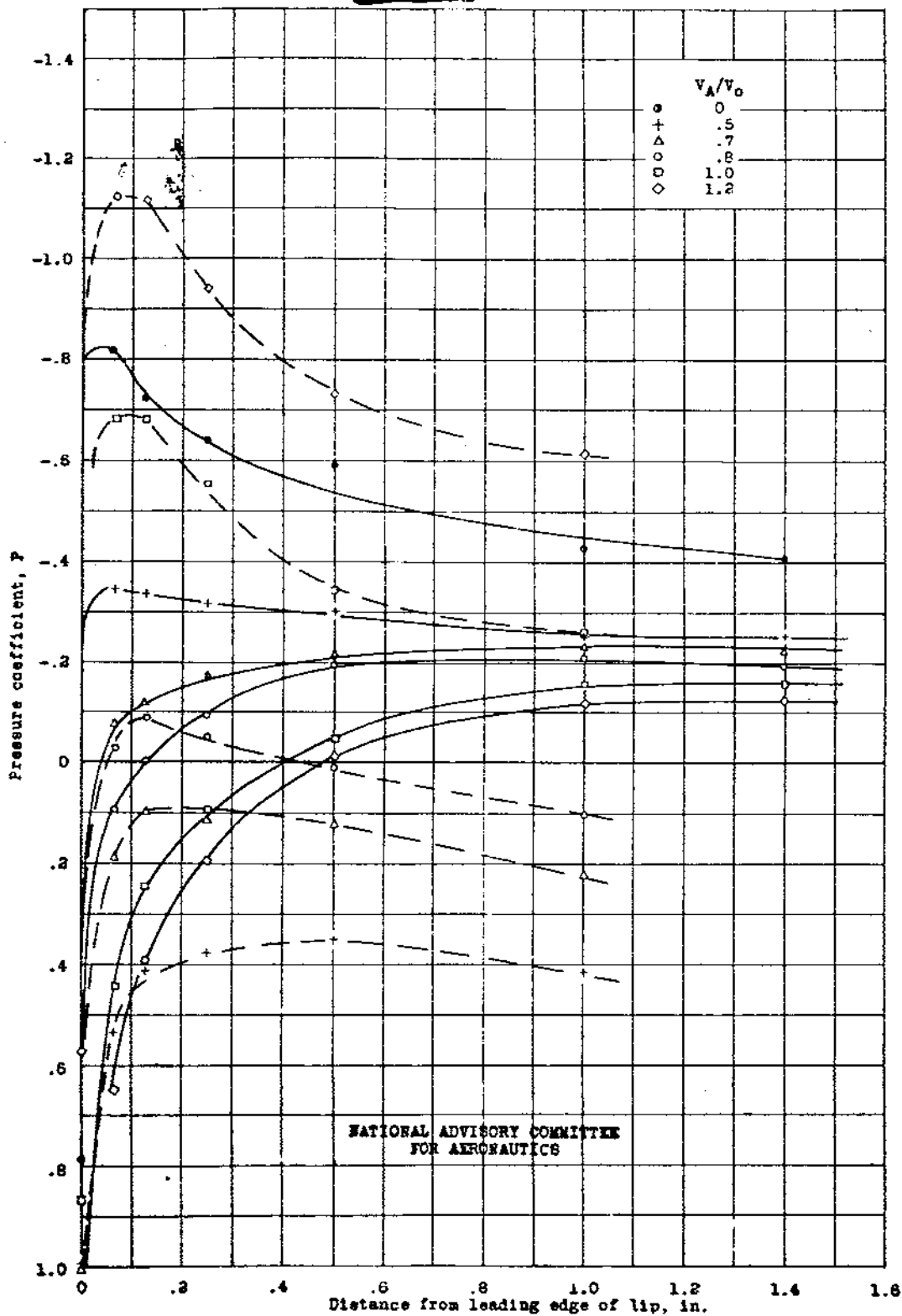

Figure 20.- Pressure distribution for various inlet-velocity ratios with lip 6 at zero incidence for a 10° ramp angle; boundary layer 1.

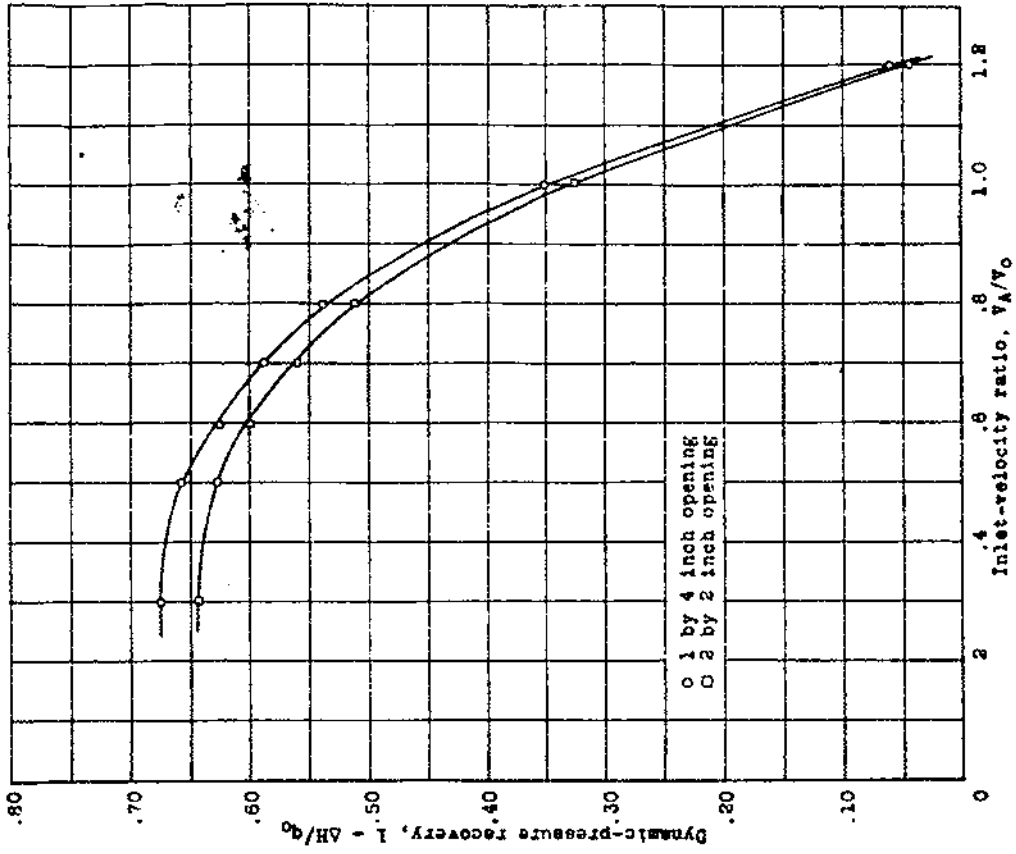

Figure 22.- The variation of dynamic-pressure recovery after diffusion with inlet-velocity ratio for two submerged-duct-entrance shapes with boundary layer 2, 70 ramp; divergence 2.

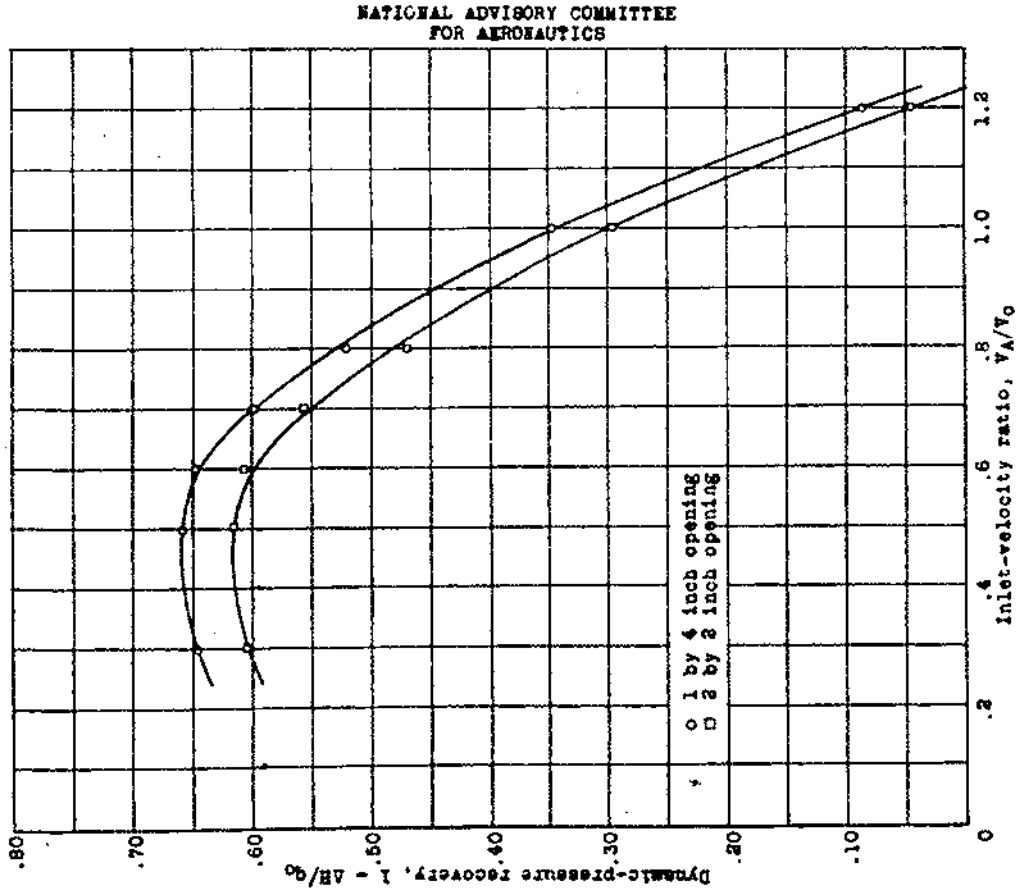

Figure 21.- The variation of dynamic-pressure recovery after diffusion with inlet-velocity ratio for two entrance shapes; 70 ramp; divergence 2.

NATIONAL ADVISORY COMMITTEE
FOR AERONAUTICS

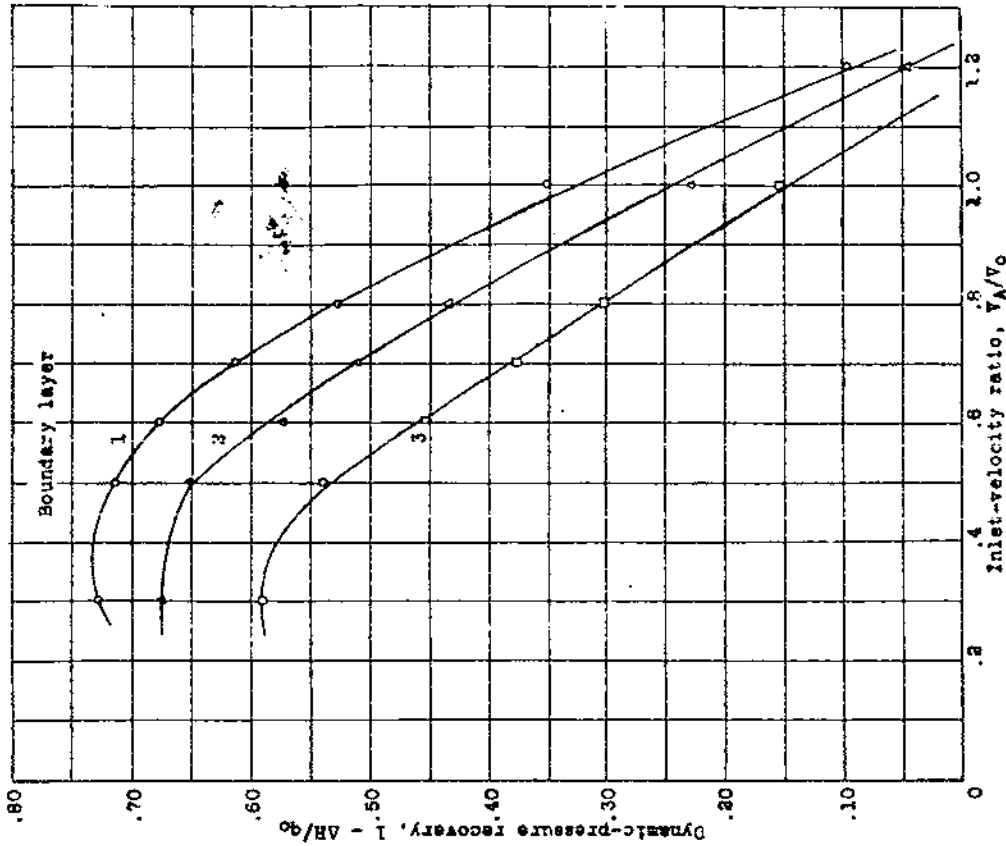

Figure 24.- The variation of dynamic-pressure recovery after diffusion with inlet-velocity ratio for three boundary-layer thicknesses; 70 diverging ramp number 4.

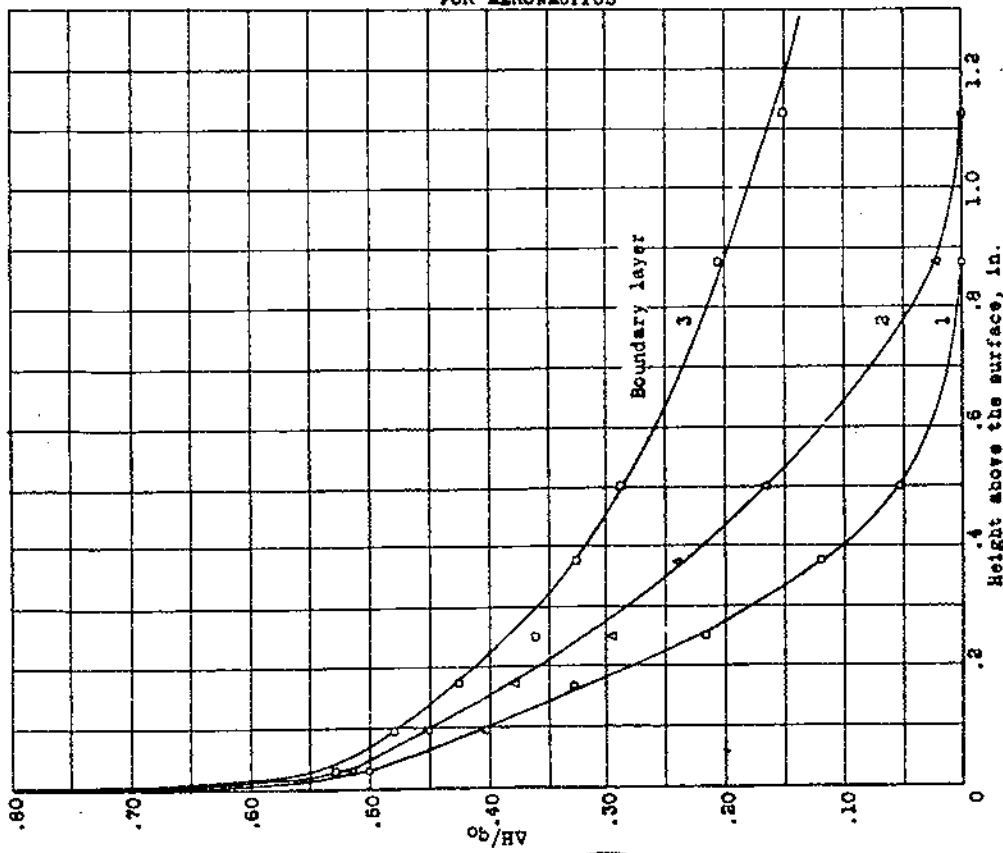

Figure 23.- Boundary layers for which submerged-duct tests were made.

NATIONAL ADVISORY COMMITTEE FOR AERONAUTICS

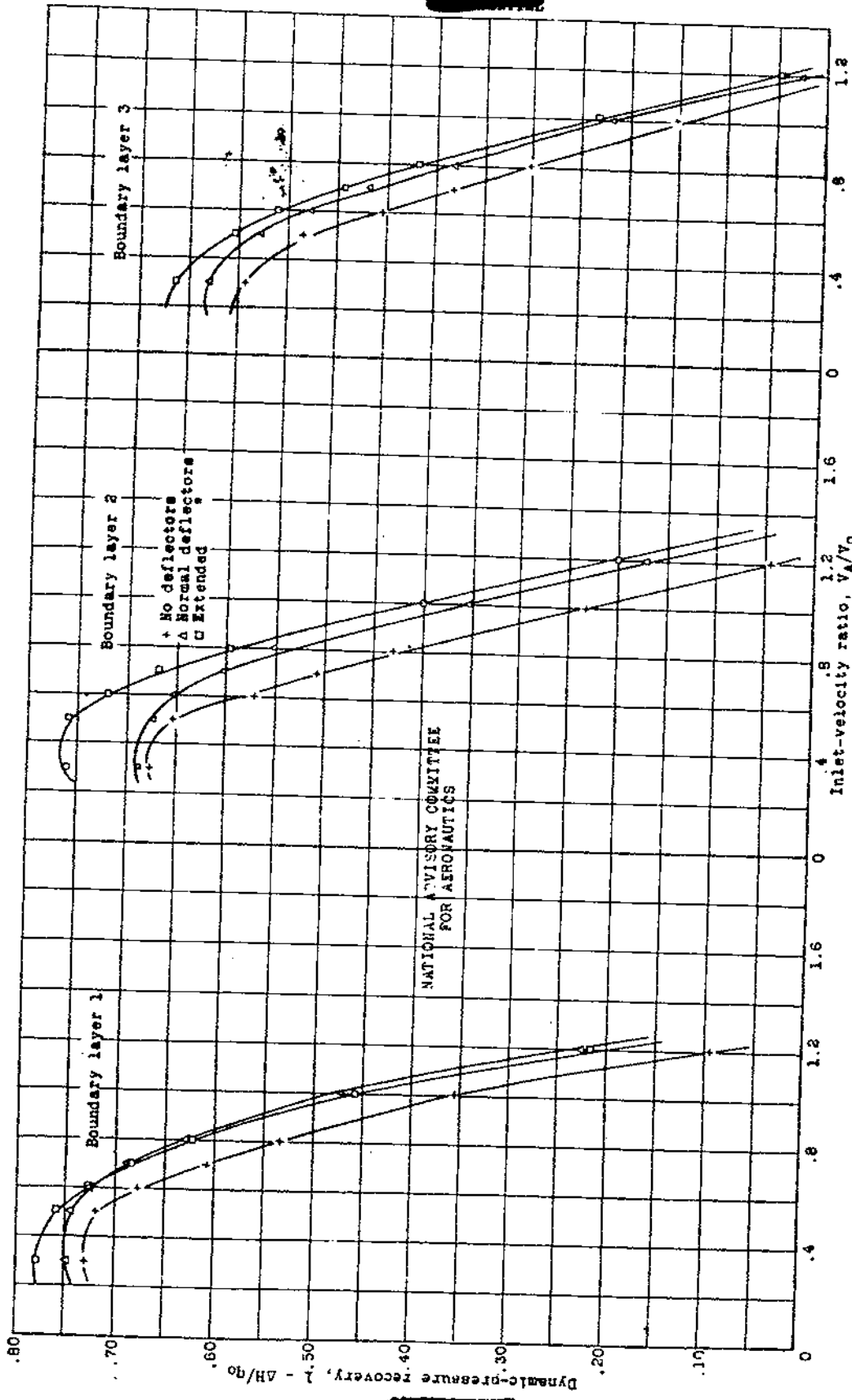

Figure 25.- The variation of dynamic-pressure recovery after diffusion with inlet-velocity ratio for various boundary layers and deflectors; 70 ramp angle; lip 6.

NATIONAL ADVISORY COMMITTEE
FOR AERONAUTICS

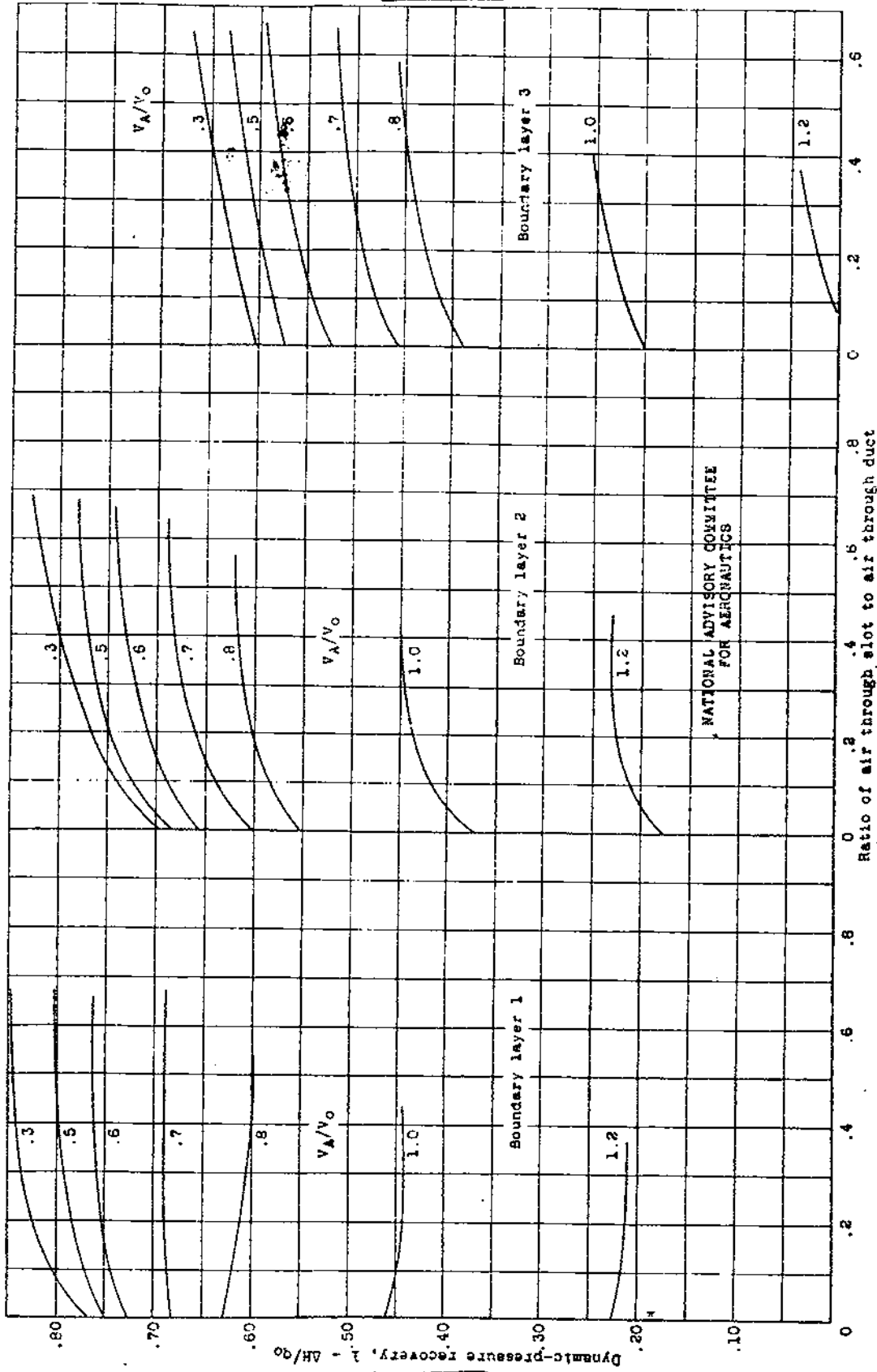

Figure 26.- The variation of dynamic-pressure recovery after diffusion with quantity of flow through the boundary-layer slot for various inlet-velocity ratios and boundary layers; 70 ramp angle; divergence ϕ ; normal deflectors.

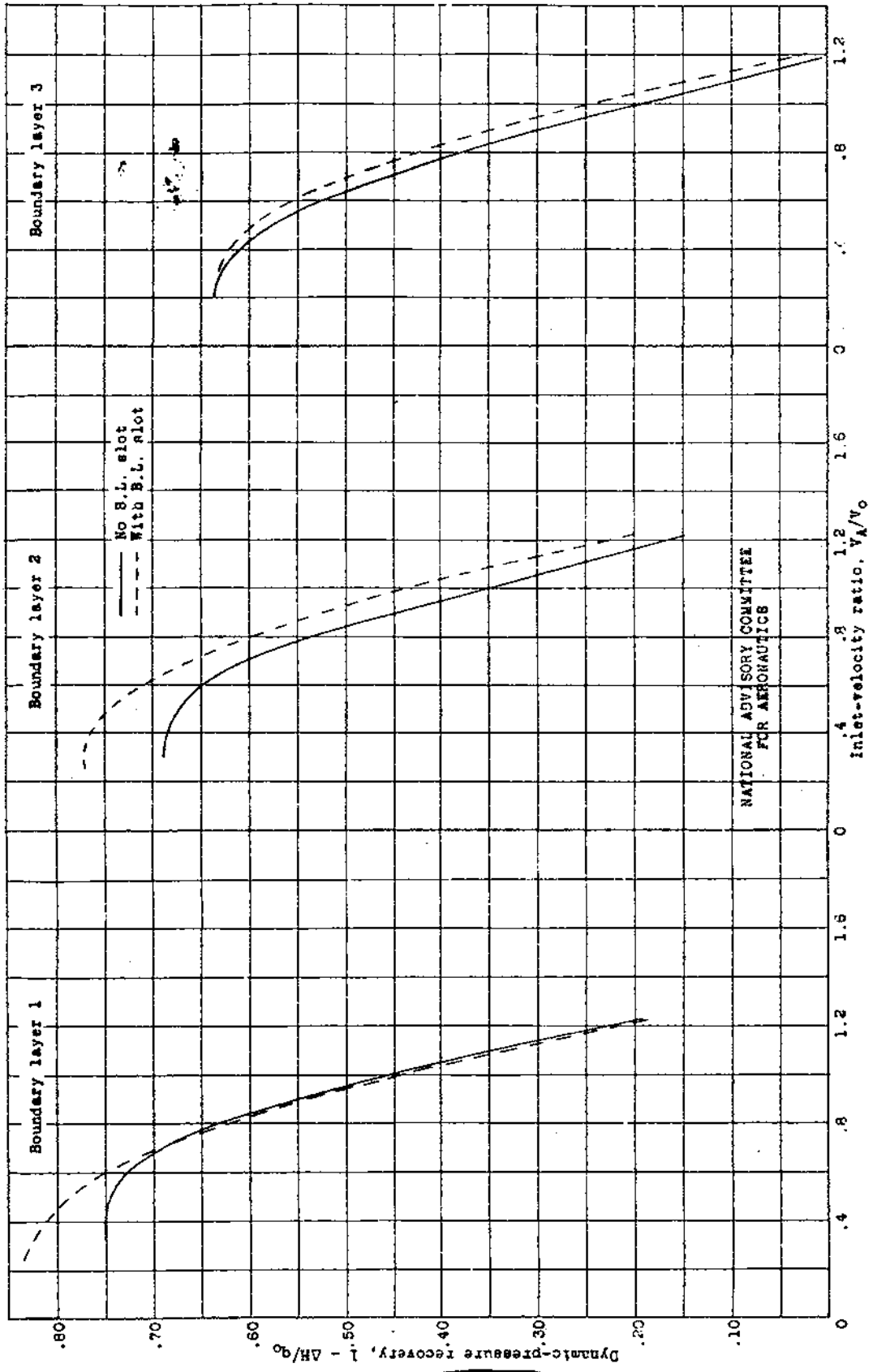

Figure 27.- The variation of dynamic-pressure recovery after diffusion with inlet-velocity ratio for 20 percent intake air drawn into the boundary layer; 70 ramp angle; divergence 4; normal deflectors.

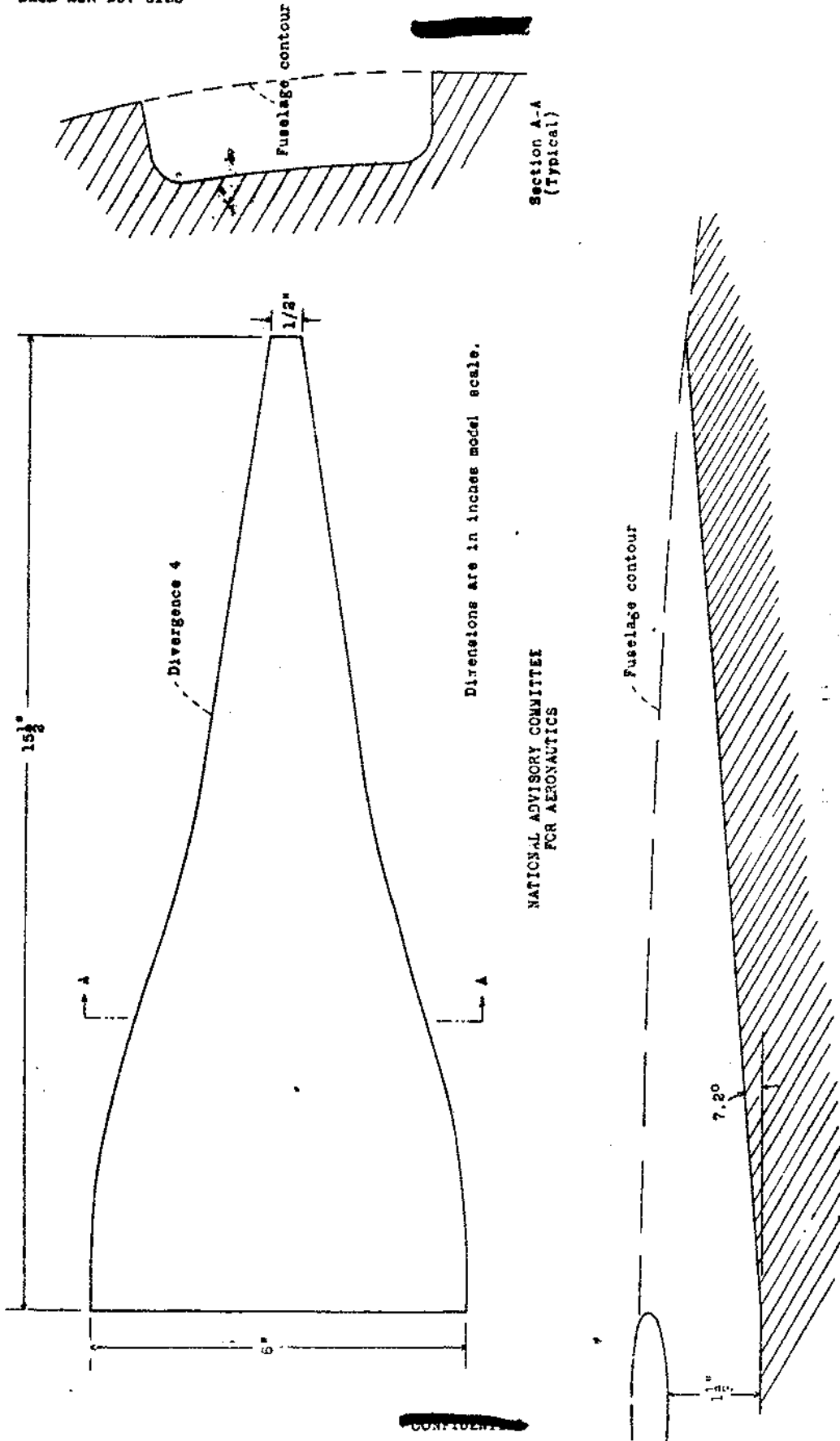

Figure 28.- Sketch of the submerged-duct entrance installed on the .25-scale model of a fighter airplane; no deflectors.

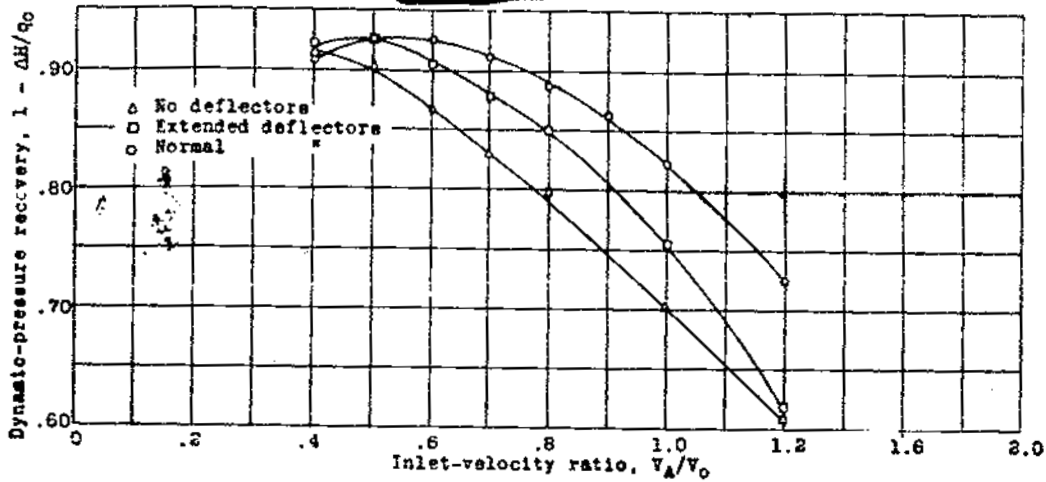

Figure 29.- Variation of dynamic-pressure recovery with inlet-velocity ratio for various deflector configurations. Submerged-duct installation on a .25-scale model of a fighter airplane. Pressure tubes mounted in entrance for comparison purposes only.

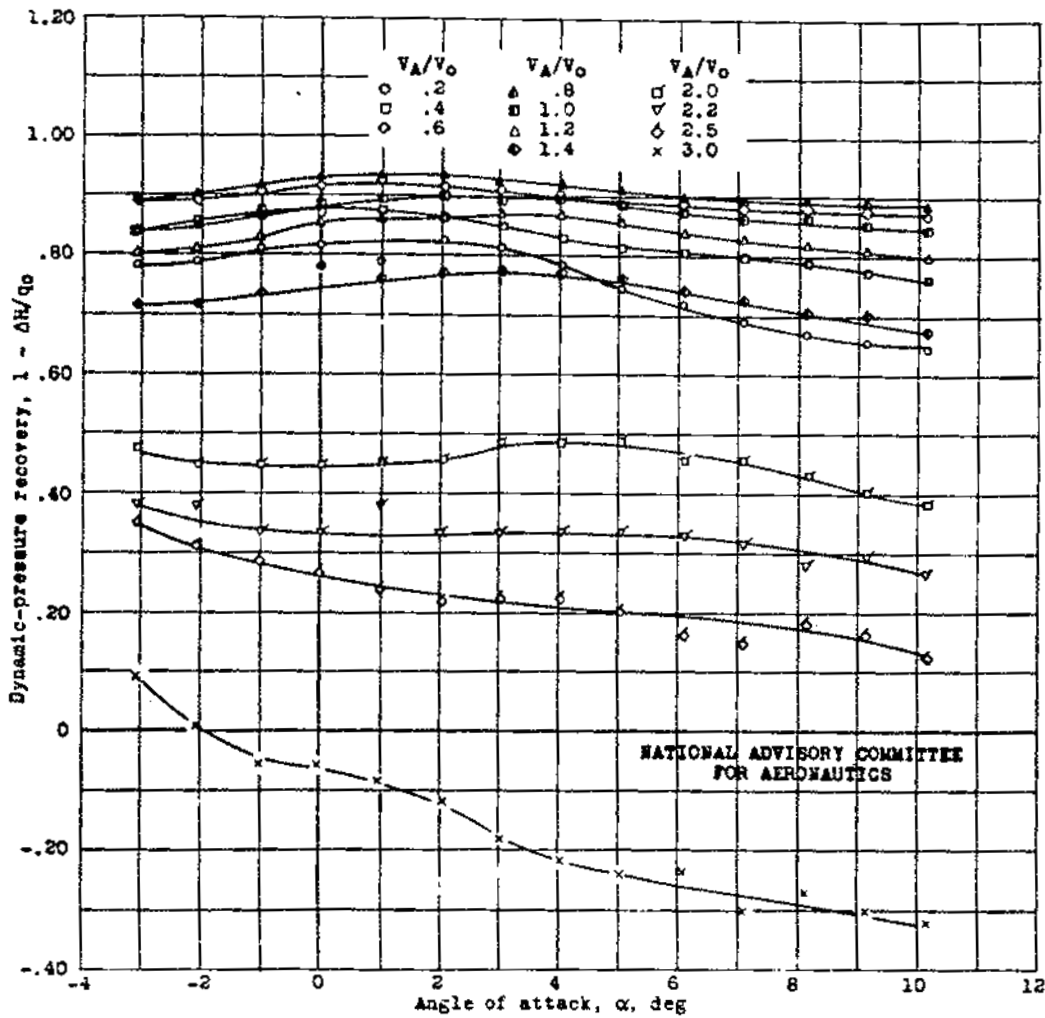

Figure 30.- Dynamic-pressure recovery of the .25-scale model of a fighter airplane with submerged-duct entries.

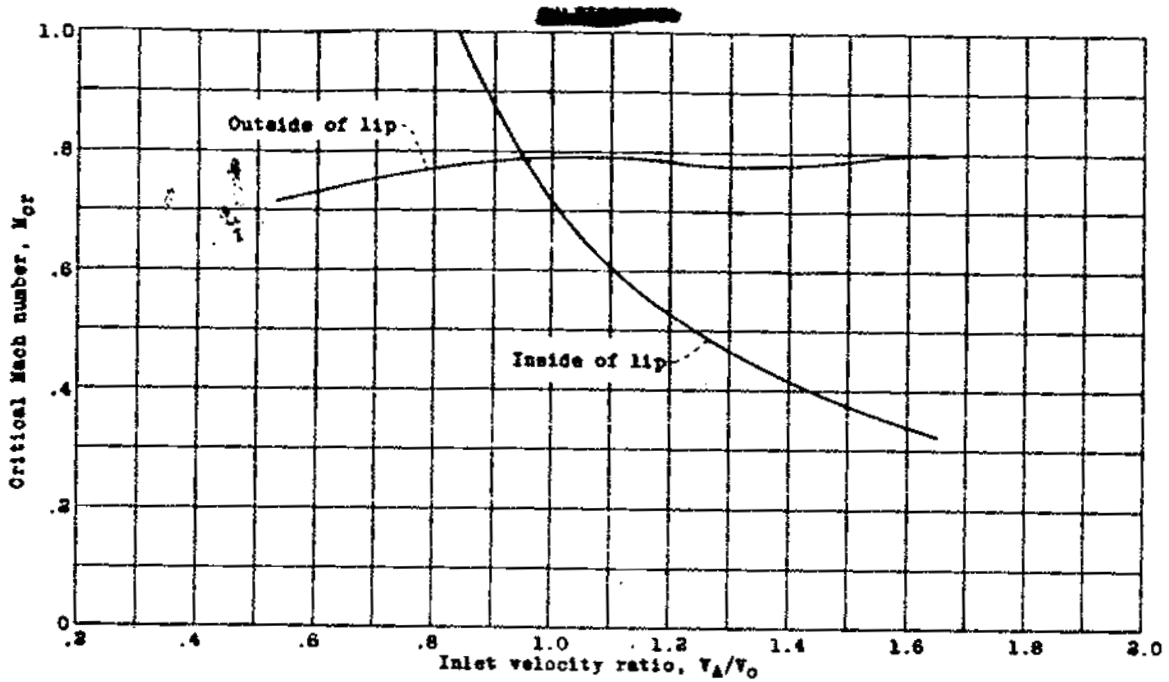

Figure 31.- Variation of critical Mach number with inlet-velocity ratio for the submerged-duct installation on the .25-scale model of a fighter airplane; matched operating conditions.

NATIONAL ADVISORY COMMITTEE
FOR AERONAUTICS

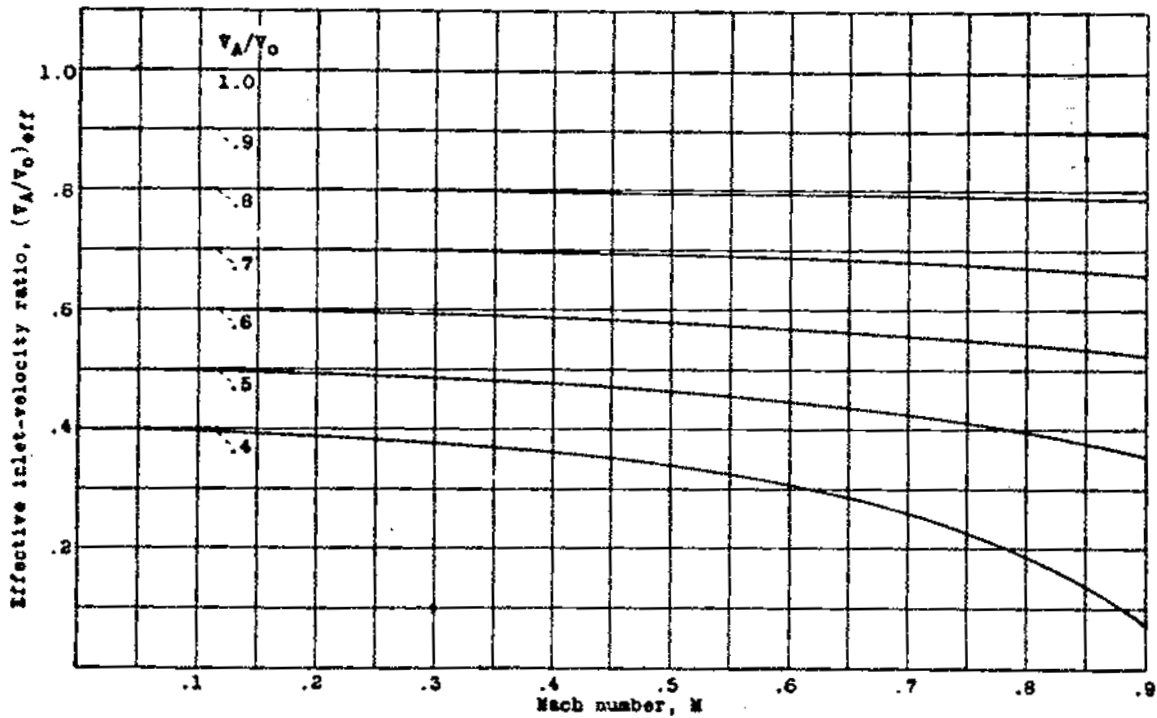

Figure 32.- Variation of effective inlet velocity with Mach number.

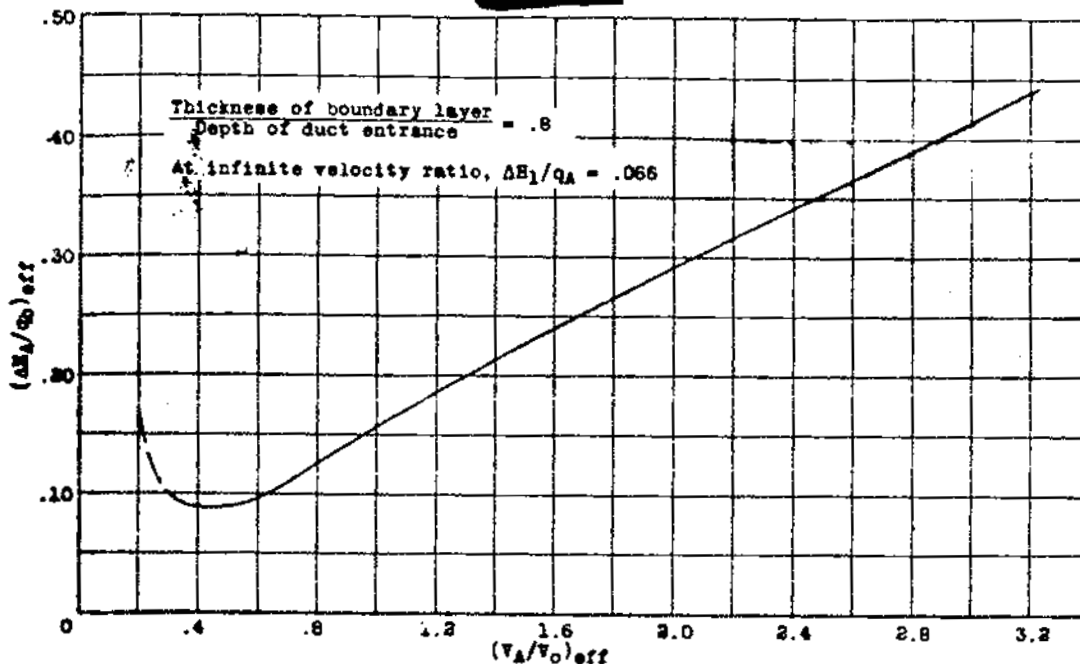

Figure 33.- Variation of effective entrance-dynamic-pressure losses with effective inlet-velocity ratio; no deflectors.

NATIONAL ADVISORY COMMITTEE
 FOR AERONAUTICS

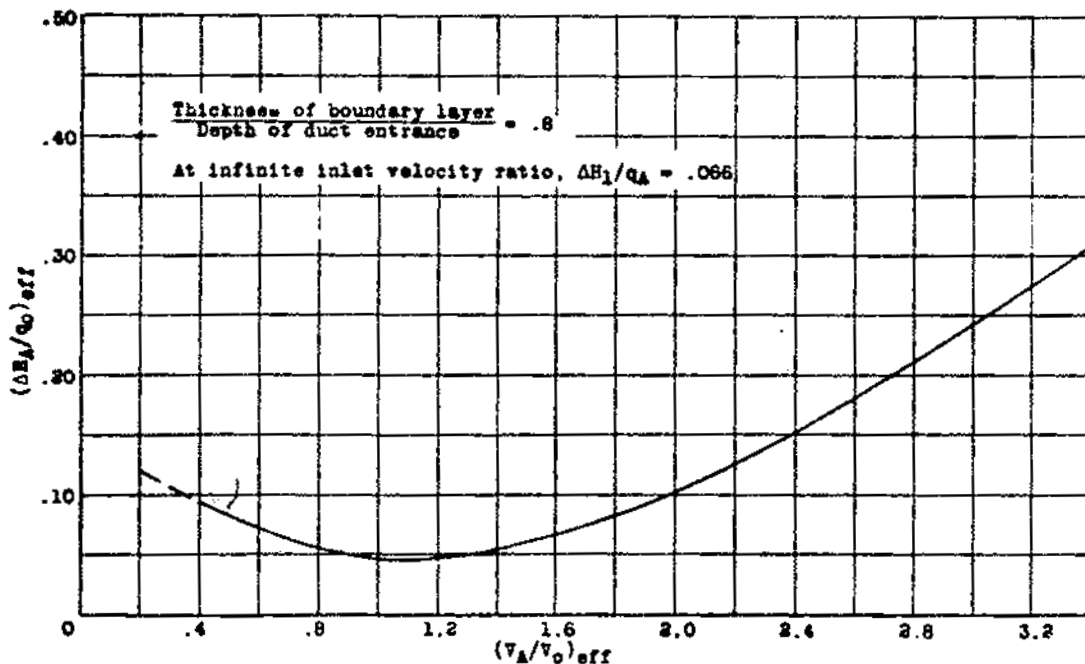

Figure 34.- Variation of effective entrance-dynamic-pressure losses with effective inlet-velocity ratio; normal deflectors.

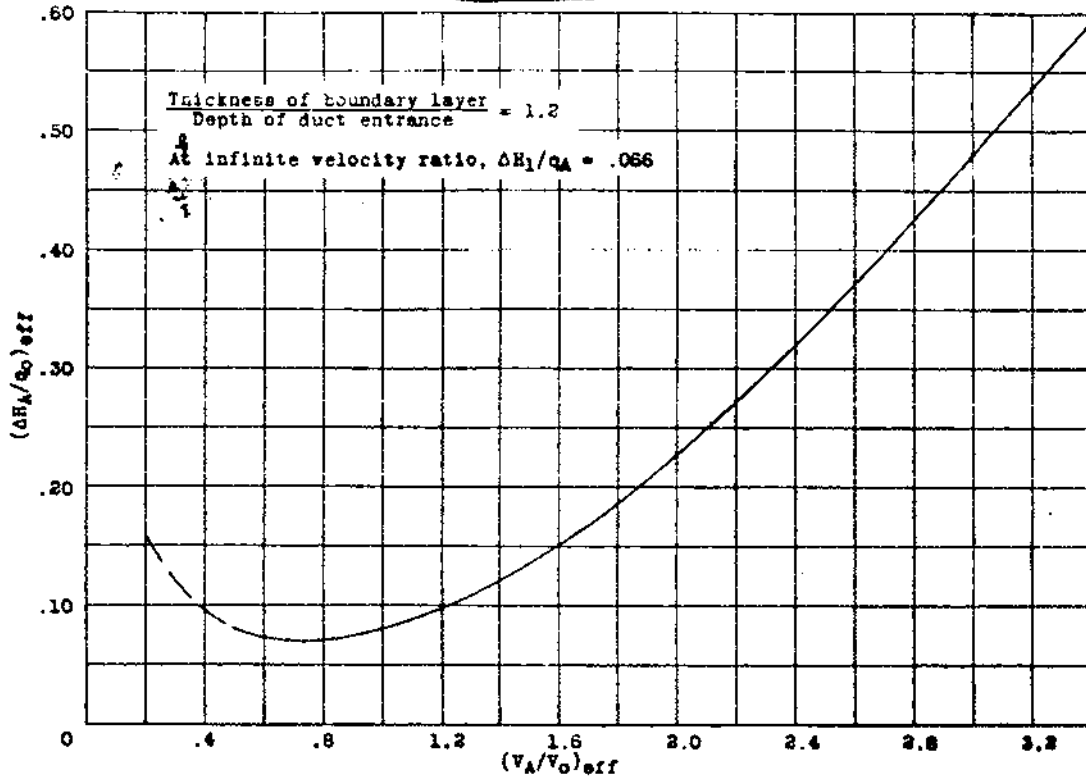

Figure 35.- Variation of effective entrance-dynamic-pressure losses with effective inlet-velocity ratio; extended deflectors; boundary layer 3.

NATIONAL ADVISORY COMMITTEE
FOR AERONAUTICS

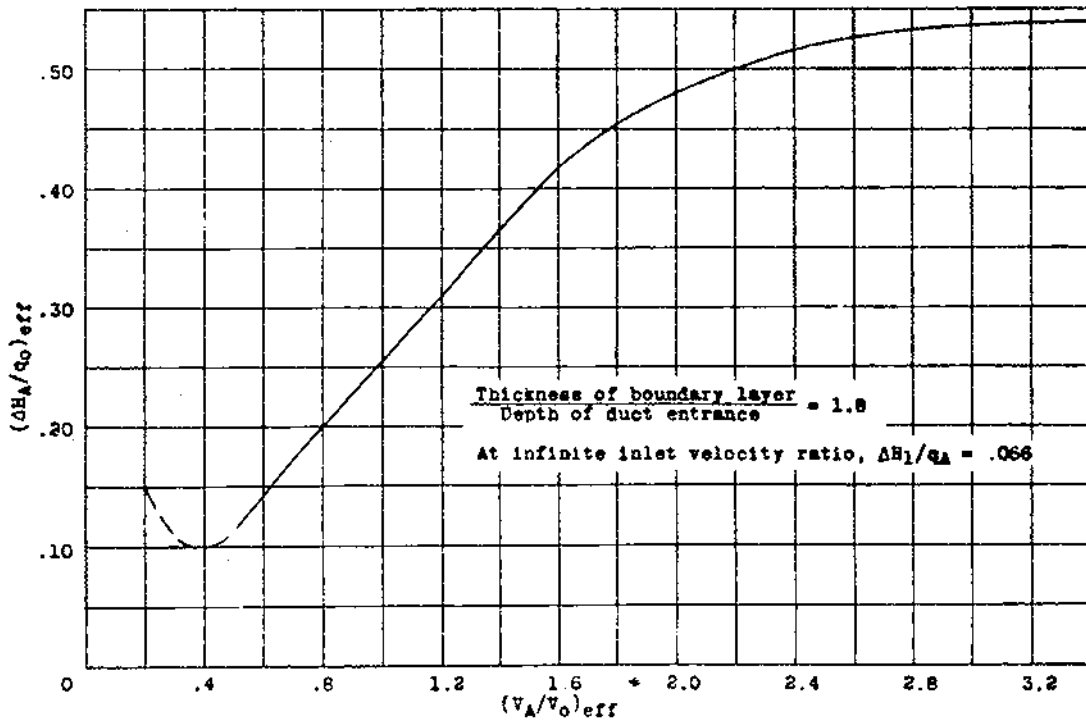
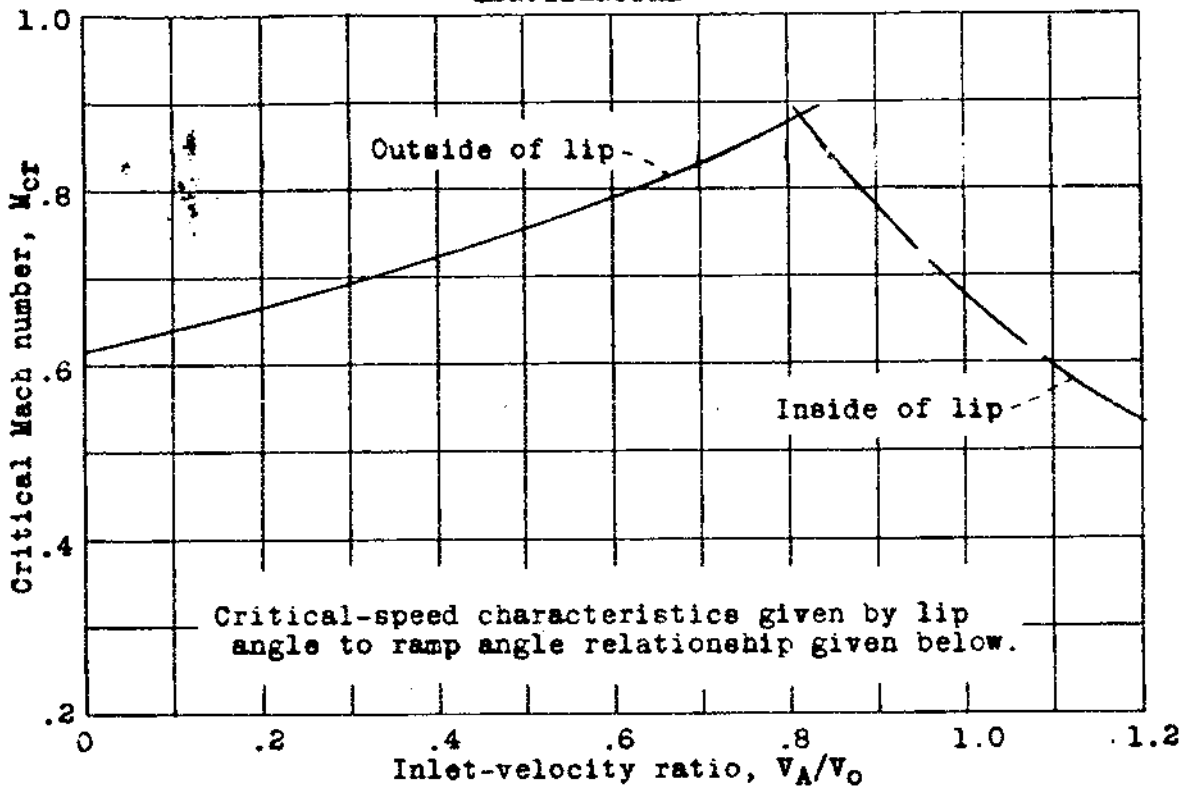

Figure 36.- Variation of effective entrance-dynamic-pressure losses with effective inlet-velocity ratio; extended deflectors; boundary layer 3.

~~CONFIDENTIAL~~



NATIONAL ADVISORY COMMITTEE
FOR AERONAUTICS

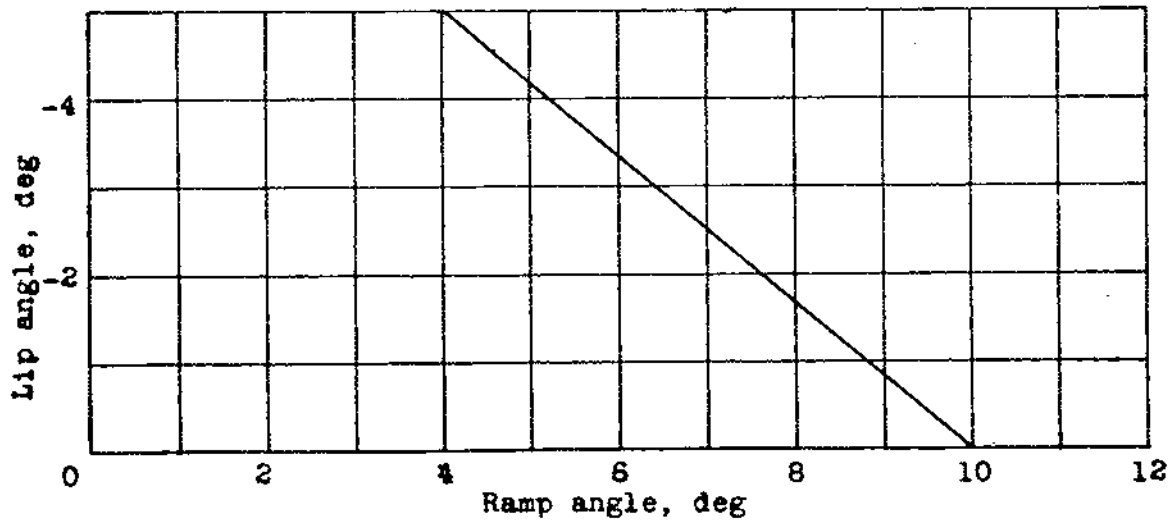
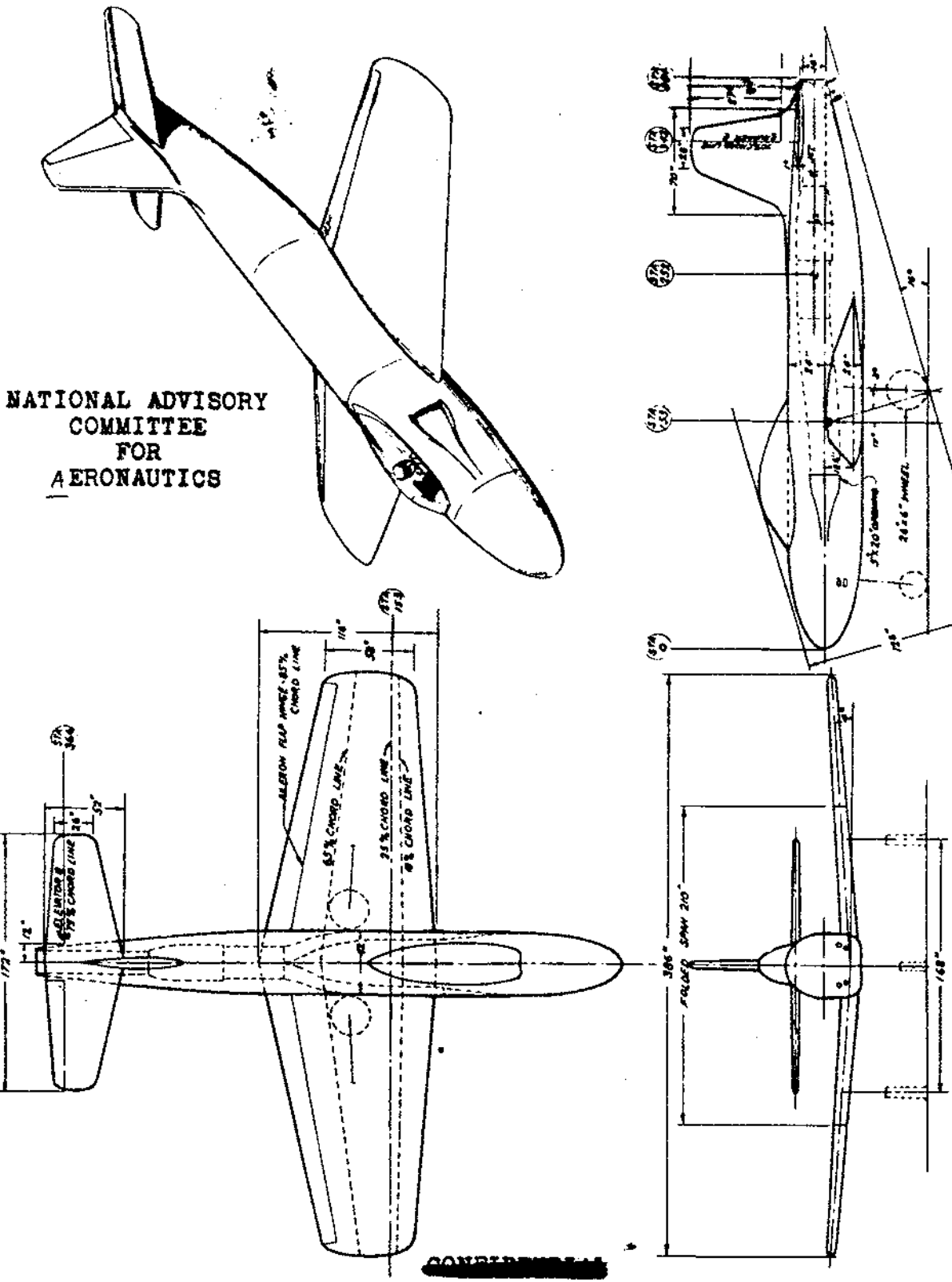

Figure 37.- The variation of the angle of lip 6 with ramp angle for the attainment of similar critical-speed characteristics.

~~CONFIDENTIAL~~

~~CONFIDENTIAL~~



NATIONAL ADVISORY
COMMITTEE
FOR
AERONAUTICS

~~CONFIDENTIAL~~

Figure 38.- Three-views of a high-speed fighter design.

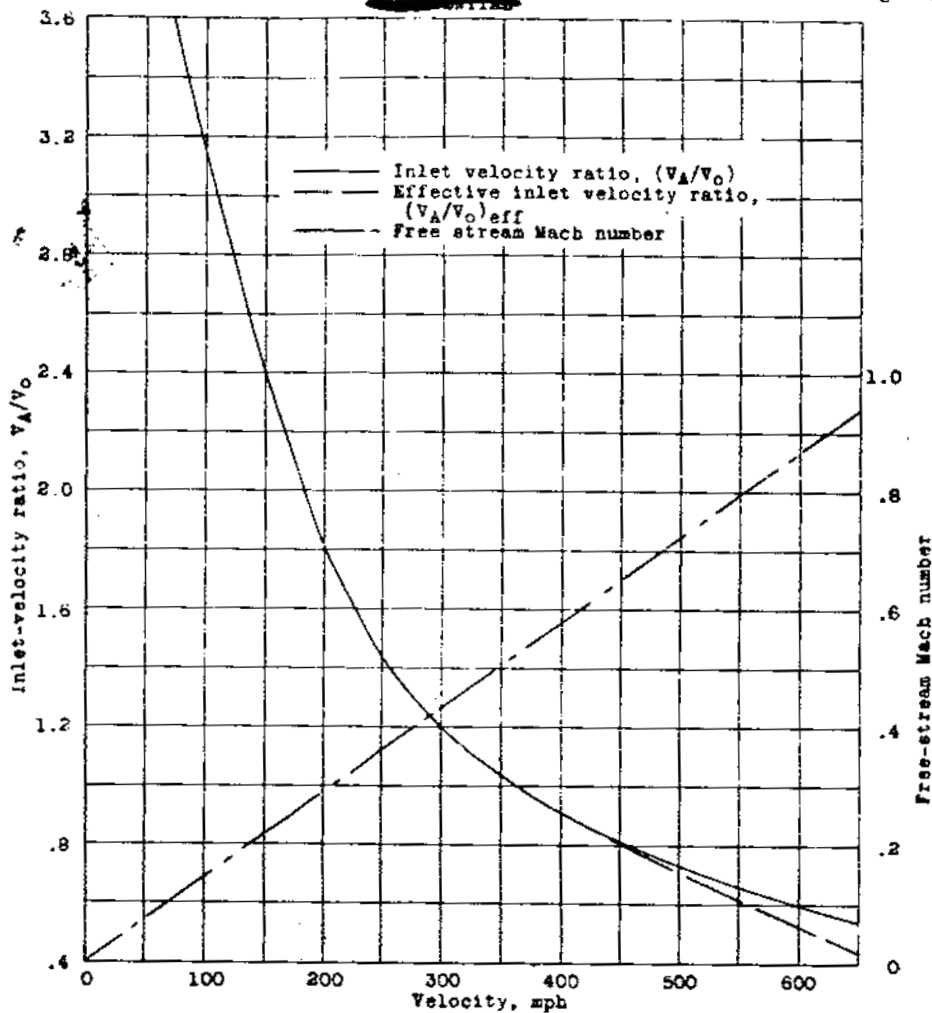

Figure 39.- Variation of inlet-velocity ratio and free-stream Mach number with velocity for a fighter-type aircraft operating at 25,000 feet; duct entrance area = 1.389 square feet.

NATIONAL ADVISORY COMMITTEE
FOR AERONAUTICS

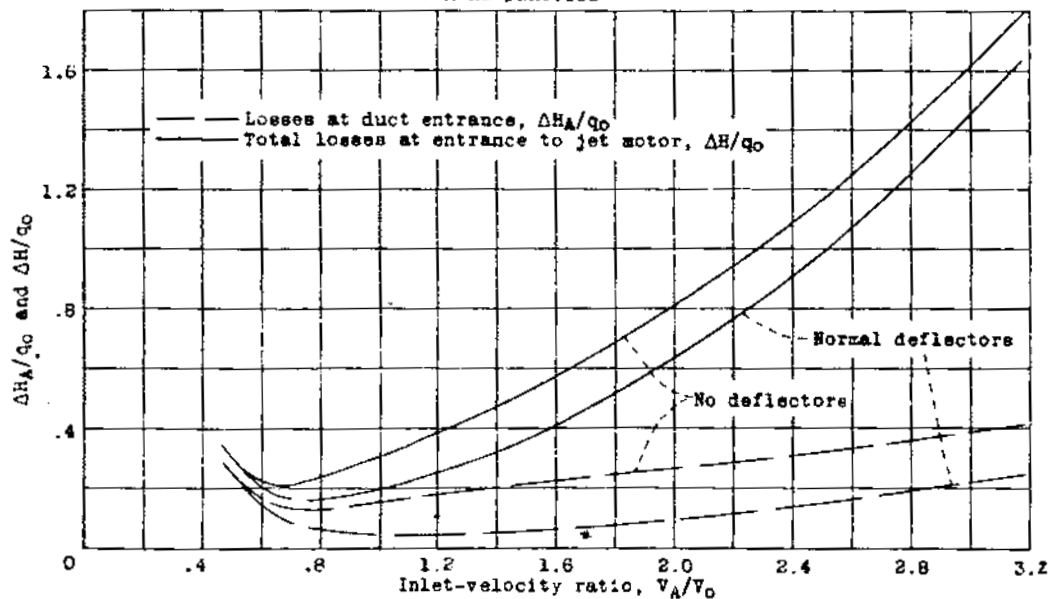

Figure 40.- Variation of estimated duct pressure losses with inlet-velocity ratio for a fighter-type aircraft operating at 25,000 feet; ducting efficiency, .85.